



**Flannery, Inc**  
Specialty Aluminum Trims

**ALUMINUM DRYWALL TRIMS**

[flannerytrim.com](http://flannerytrim.com) - 800.765.7585



# TABLE OF CONTENTS

OUR STORY _____	02
PRODUCT OVERVIEW _____	03
SHAPEFINDER _____	04
REVEALS _____	07
DRYWALL REVEAL _____	08
DRYWALL V-REVEAL _____	10
DRYWALL CEILING TRIM _____	11
CONCEALED FASTENER TRIM _____	13
TERMINATION TRIMS _____	15
DRYWALL F-MOLD _____	16
DRYWALL SHADOW MOLD _____	18
DRYWALL T-MOLD _____	20
W-TRANSITION MOLD _____	21
DRYWALL L-METAL _____	22
REVERSE L-METAL _____	24
DRYWALL END ENCLOSURE _____	25
DRYWALL GLAZING TRACK _____	26
VENEER PLASTER J-MOLD _____	27

DRYWALL PROTRUSION EDGE TRIM _____	28
CORNER TRIMS _____	29
DRYWALL REVEAL CORNER _____	30
DRYWALL OUTSIDE CORNER _____	31
BEVELED DRYWALL CORNER _____	32
DRYWALL PROTRUSION EDGE CORNER _____	33
LED TRIMS _____	35
LED DRYWALL REVEAL _____	36
LED DRYWALL HOUSING MOLD _____	37
LED BASE MOLDING _____	38
LED CEILING MOLD _____	39
LED DRYWALL POCKET TRIM _____	40
LED PANEL SCREED _____	41
LED FLUSH SCREED _____	42
INTERSECTIONS & RADIUS _____	44
PRODUCT SPECIFICATIONS _____	48

# OUR STORY



Since 1975, **Flannery Inc.** has been the premier manufacturer of aluminum and steel trims. Family-owned and operated, we have manufactured a range of trim products— fabricated solely in the United States— that are designed to complement both interior and exterior wall systems. We have grown from producing trims for drywall and stucco to a full line of panel and ceiling trims. Our full production and fabrication facility boasts one of the largest product inventories of niche extruded aluminum construction trims. We are dedicated to providing more than the necessary technical assistance and customer service that will enable any builder, architect, or owner to succeed in their building design.



# PRODUCT OVERVIEW

In 1975, Flannery's founder Bud Rutherford began producing his very first trim product which was Metal Fast Mask®. This innovative drywall trim took a simple L-Metal and added a tear-away strip to save the cost of masking such a trim prior to applying compound joints to the wall. The removal of this single step in the labor process saved countless hours of labor on thousands of jobs over the years. This kind of cost savings is what you will find when you select a Flannery Aluminum Drywall Trim.

While Fast Mask® is a steel product, Flannery turned its focus to Aluminum Trims for drywall in the early 1980's and has grown to offer trims for five different types of wall systems. This brochure covers Flannery's current scope of Aluminum Trims offered for drywall and gypsum board installations. The first trim offered from Flannery was a drywall trim and we continue this legacy by offering over 25 different trim shapes for interior wall construction including products for LED Lighting.

Be sure to review the many factory fabricated accessories that we offer for all of our Aluminum Drywall Trims outlined in the back of this brochure. In addition to the trim products in this brochure, be sure to visit [flannerytrim.com](http://flannerytrim.com) to view our various trims for Plaster/Stucco, Fiber Cement Panels, Millwork Panels and Suspended Ceilings.



# SHAPEFINDER

-  REVEALS
-  TERMINATION TRIMS
-  CORNER TRIMS
-  LED TRIMS

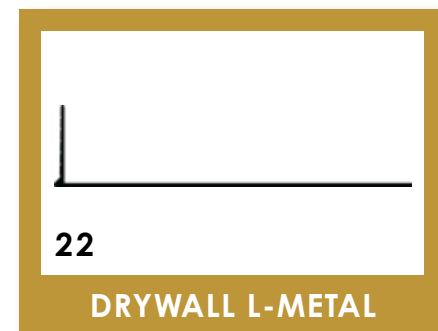
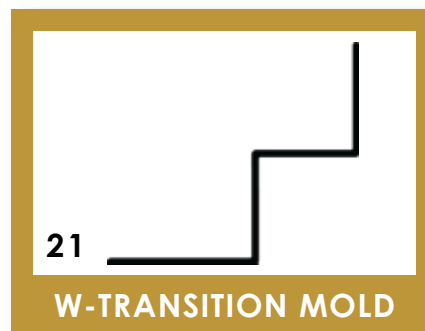
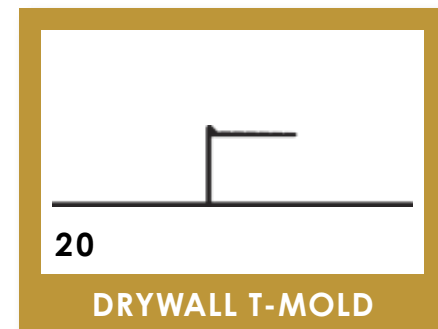
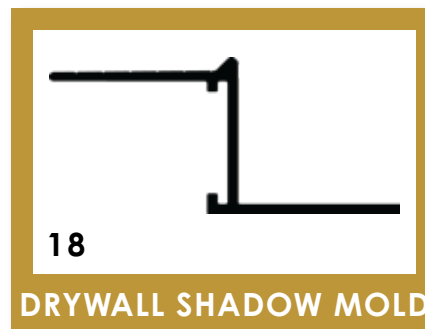
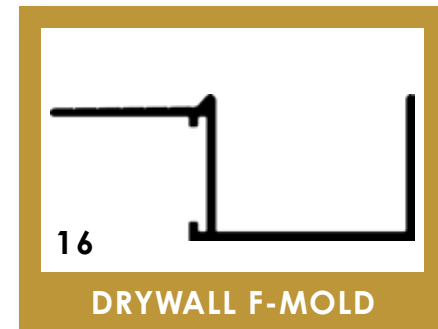
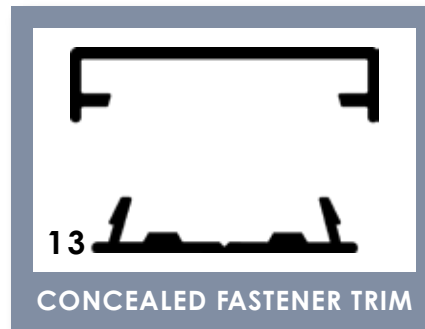
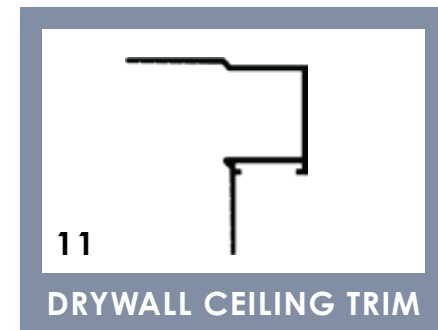
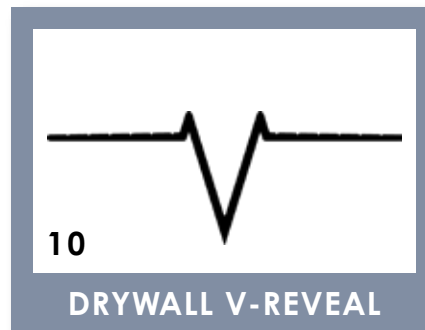
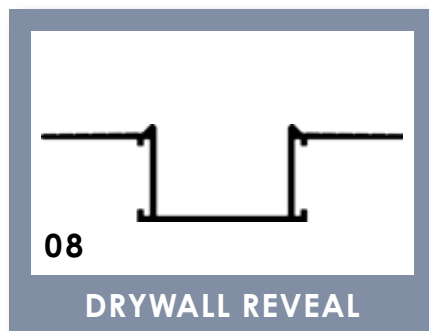

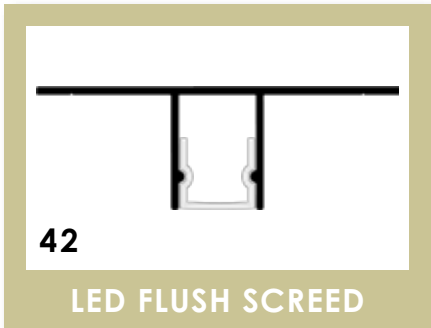
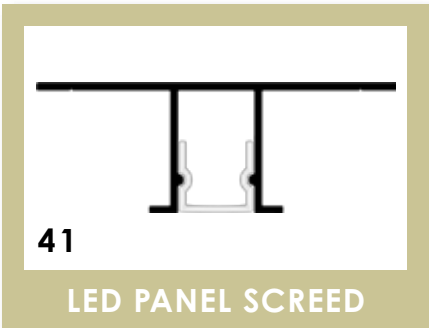
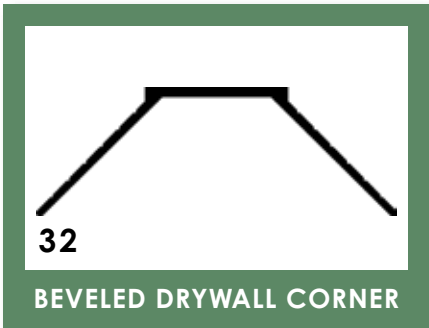
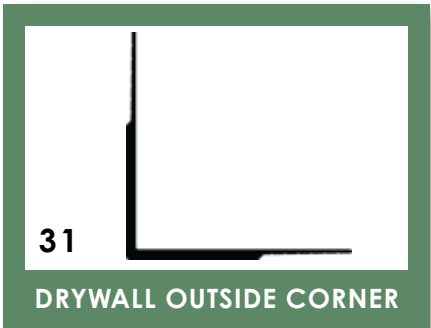
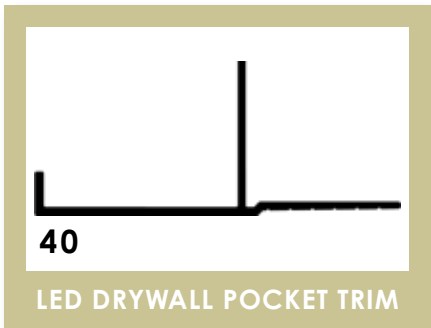
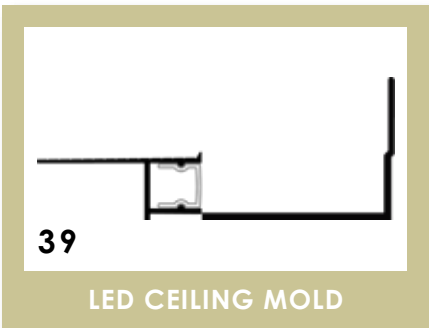
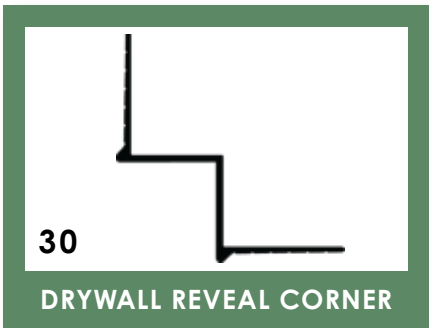
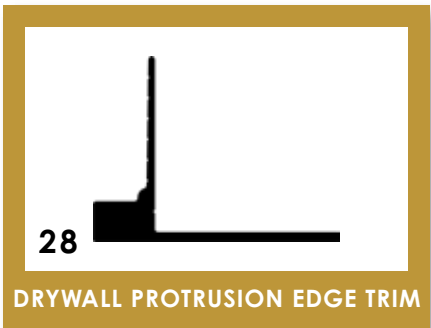
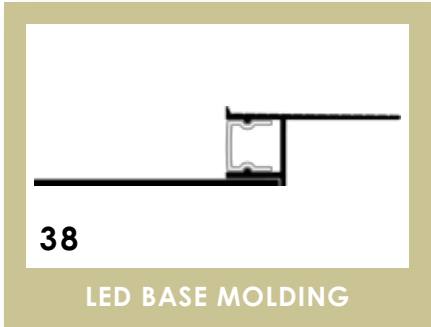
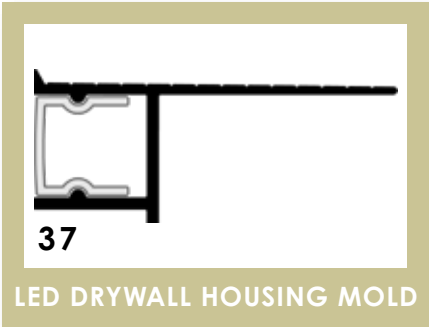
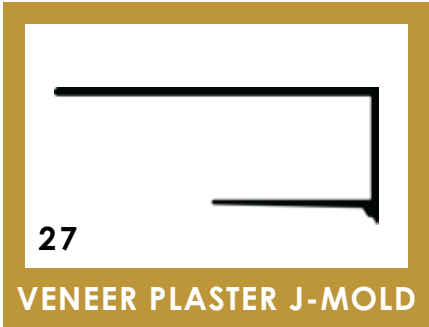
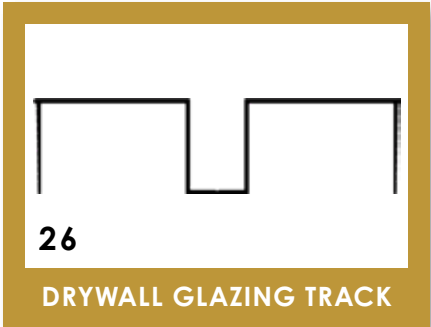
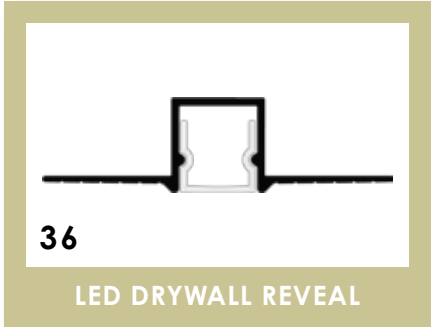
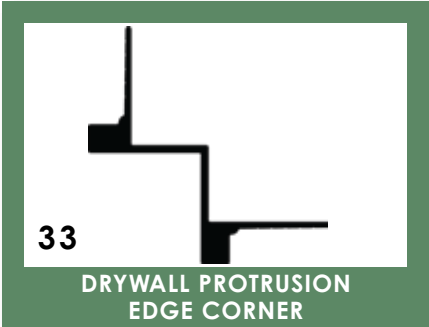
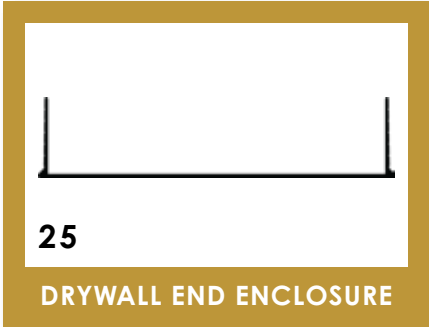
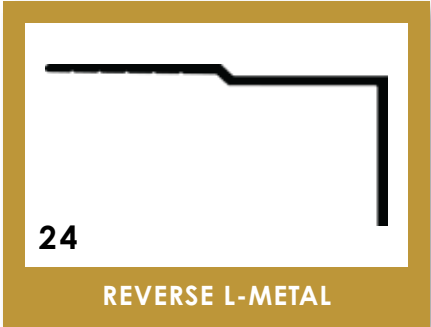

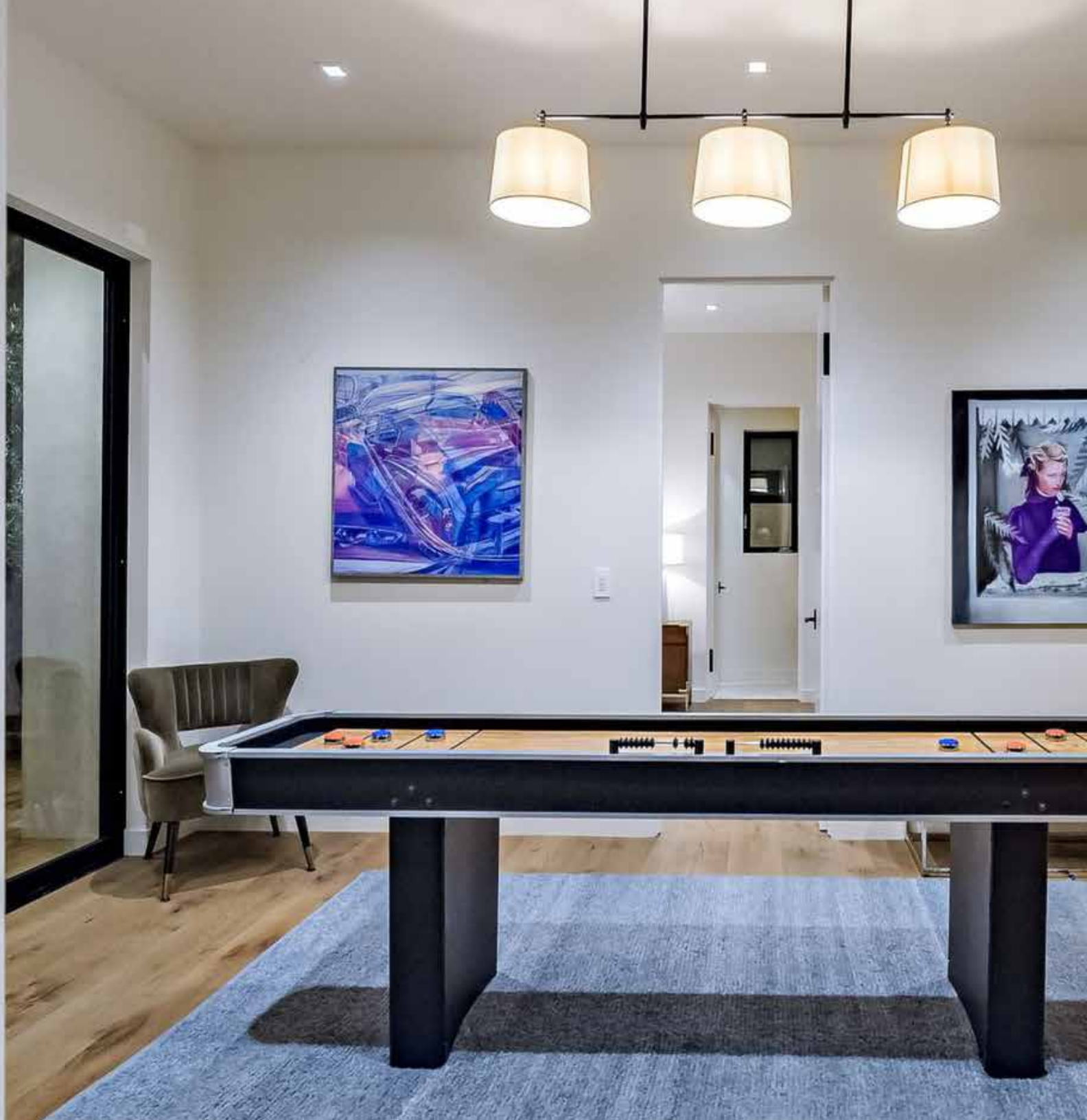





# REVEALS

- DRYWALL REVEAL
- DRYWALL V-REVEALS
- DRYWALL CEILING TRIM
- CONCEALED FASTENER TRIM

# DRYWALL REVEAL

## TRIM PURPOSE

Flannery's Drywall Reveals create an aesthetic division between drywall panels on vertical walls and ceilings. Drywall Reveals can be used to create horizontal or vertical lines and can intersect cleanly where desired. Flannery offers many of its Drywall Reveals with Aluminum Alignment Splices to ease the installation process and create crisp and clean butt joints and lines.

## SPECIFICATIONS

Flannery's Aluminum Drywall Trims are standard extruded aluminum alloy 6063 T5 and have .050" nominal wall thickness. Drywall trims come in 10' lengths and shall have a standard Mill Finish (for field priming & painting) or a Clear Anodized Finish. Other factory finishes and custom paint orders, including Chem-film or Primer, are available.

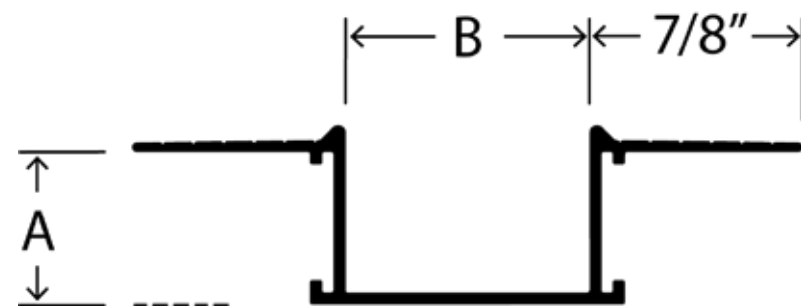
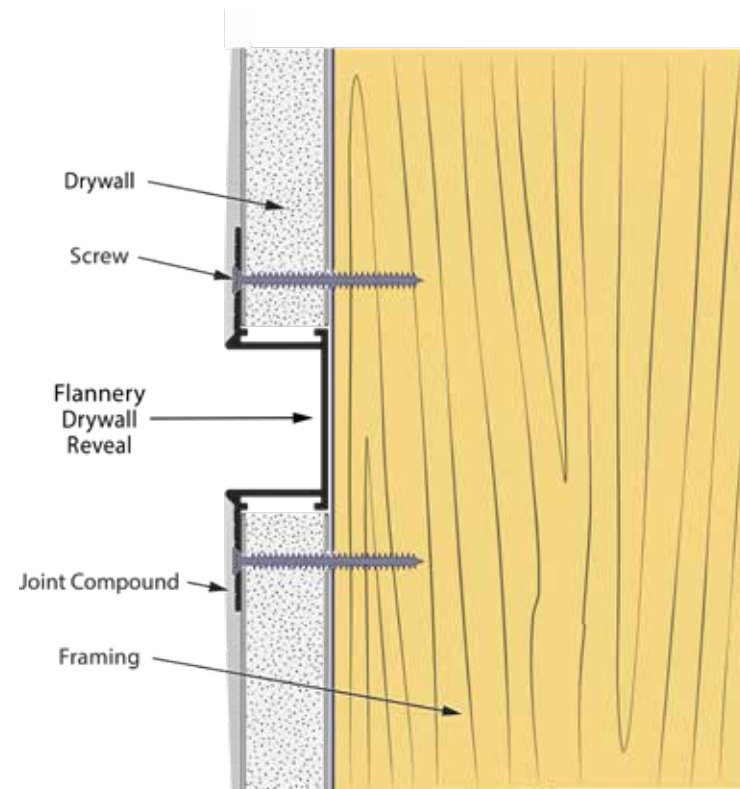

## PRODUCT CHART

PART NO.	"A" DEPTH	"B" WIDTH	VENTING AVAILABLE
DWR 375-375	3/8"	3/8"	N/A
DWR 50-125	1/2"	1/8"	N/A
DWR 50-25	1/2"	1/4"	N/A
DWR 50-375	1/2"	3/8"	N/A
DWR 50-50	1/2"	1/2"	YES
DWR 50-75	1/2"	3/4"	YES
DWR 50-100	1/2"	1"	YES
DWR 50-150	1/2"	1 1/2"	YES
DWR 50-200	1/2"	2"	YES
DWR 50-300	1/2"	3"	YES
DWR 50-600	1/2"	6"	YES
DWR 625-25	5/8"	1/4"	N/A
DWR 625-375	5/8"	3/8"	N/A
DWR 625-50	5/8"	1/2"	YES
DWR 625-625	5/8"	5/8"	YES
DWR 625-75	5/8"	3/4"	YES
DWR 625-100	5/8"	1"	YES
DWR 625-150	5/8"	1 1/2"	YES
DWR 625-200	5/8"	2"	YES
DWR 625-300	5/8"	3"	YES
DWR 625-400	5/8"	4"	YES



# DRYWALL V-REVEALS

## TRIM PURPOSE

Flannery's Drywall V-Reveals create an aesthetic division between drywall panels on vertical walls and ceilings. Drywall V-Reveals can be used to create horizontal or vertical lines and can intersect cleanly where desired. V-Reveals have a unique angle appearance once installed compared to the normally "square" look of most drywall reveals.

## SPECIFICATIONS

Flannery's Aluminum Drywall Trims are standard extruded aluminum alloy 6063 T5 and have .050" nominal wall thickness. Drywall trims come in 10' lengths and shall have a standard Mill Finish (for field priming & painting) or a Clear Anodized Finish. Other factory finishes and custom paint orders, including Chem-film or Primer, are available.

## PRODUCT CHART

PART NO.	"A" DEPTH	"B" WIDTH
DWV 375-75	3/8"	3/4"
DWV 625-375	5/8"	3/8"
DWV 625-100	5/8"	1"

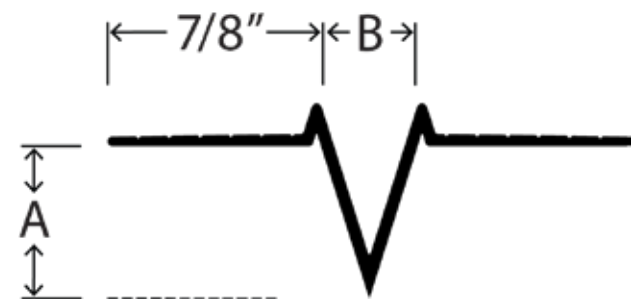
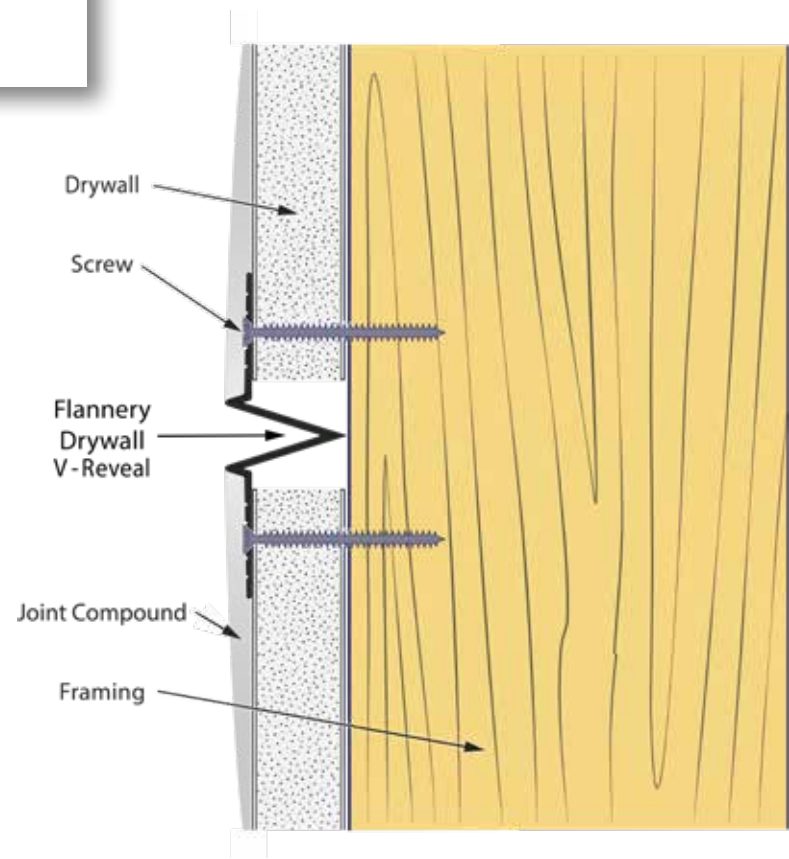



# DRYWALL CEILING TRIM

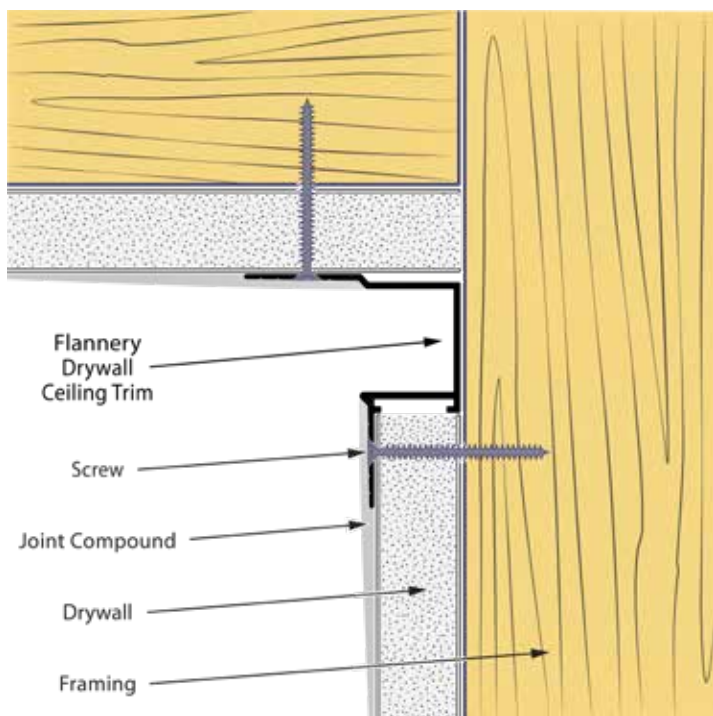
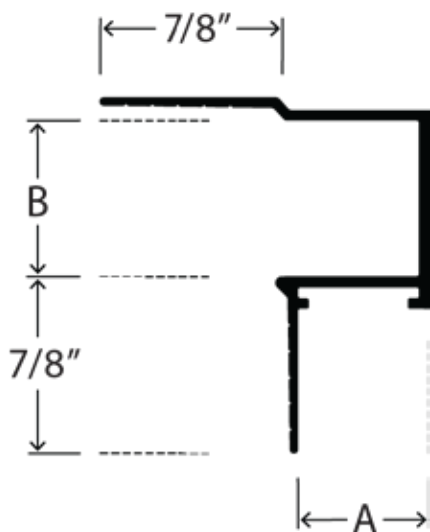

## TRIM PURPOSE

Flannery's Drywall Reveal Ceiling Trim creates an aesthetic reveal between vertical walls and ceilings that both utilize drywall. Drywall Ceiling Trims are used to terminate drywall at the top of vertical walls and is attached to both the wall and the ceiling.

## SPECIFICATIONS

Flannery's Aluminum Drywall Trims are standard extruded aluminum alloy 6063 T5 and have .050" nominal wall thickness. Drywall trims come in 10' lengths and shall have a standard Mill Finish (for field priming & painting) or a Clear Anodized Finish. Other factory finishes and custom paint orders, including Chem-film or Primer, are available.

## PRODUCT CHART

PART NO.	"A" DEPTH	"B" WIDTH
DWRCT 50-50	1/2"	1/2"
DWRCT 625-25	5/8"	1/4"
DWRCT 625-75	5/8"	3/4"
DWRCT 625-100	5/8"	1"

MEADOWS MALL  
the GGP Classifieds collection



FOREVER 21  
G. BY GUESS  
THE DISNEY STORE  
CHARLOTTE RUSSE  
CHARMING CHARLIE  
U.S. POLO ASSN.  
AND MORE...

YOU'RE AT  
THE CENTER OF  
THE HOTTEST  
TRENDS

Over 120 stores to find  
all the latest fashions.

MeadowMall.com

★ macy's

BEST BUY mobile

BEST BUY mobile

BEST BUY

FOOTACTION

MOBILE

T-Mobile

More DATA \$35

VIDEO RENTALS FREE

USA \$2000 CASHBACK

BOUNDS

LOW GIFT

WASH YOUR CAR

WASH YOUR CAR



# CONCEALED FASTENER TRIM

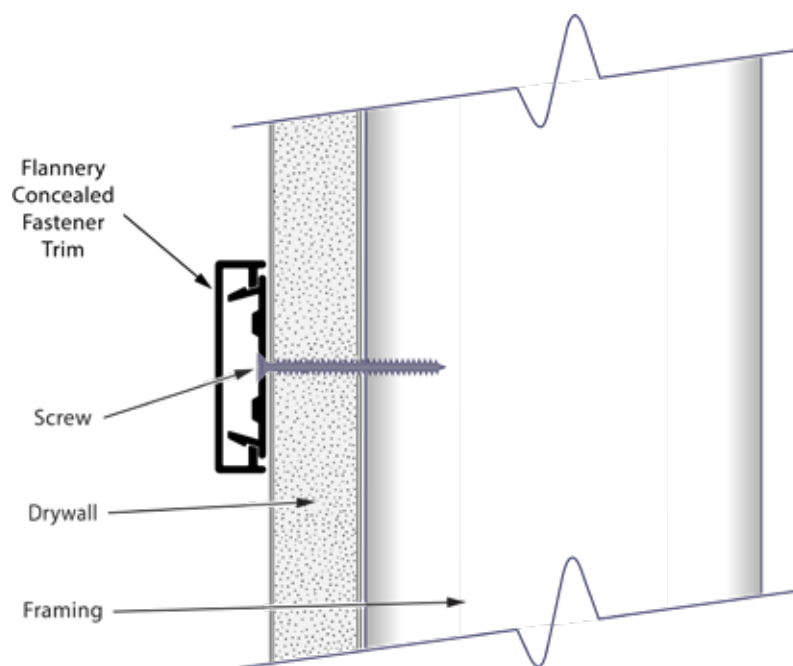
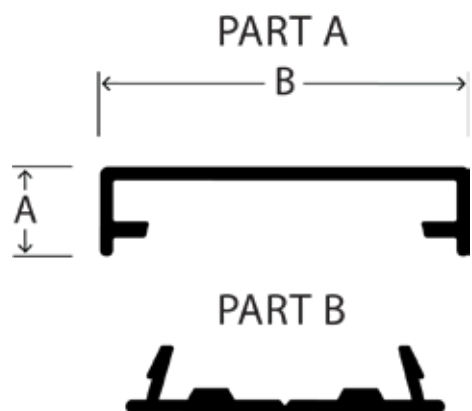

## TRIM PURPOSE

Flannery's Concealed Fastener Trim is an Aluminum trim that creates a raised feature strip over the face of a finished wall. The Concealed Fastener Trim is a two-piece trim that once installed sits proud of the wall while hiding all of the trim's fasteners. Part B of the trim is attached to the wall's substrate first and then Part A is "snapped" over Part B thus concealing all of the fasteners of the trim.

## SPECIFICATIONS

Flannery's Aluminum Drywall Trims are standard extruded aluminum alloy 6063 T5 and have .050" nominal wall thickness. Drywall trims come in 10' lengths and shall have a standard Mill Finish (for field priming & painting) or a Clear Anodized Finish. Other factory finishes and custom paint orders, including Chem-film or Primer, are available.

## PRODUCT CHART

PART NO.	"A" HEIGHT	"B" WIDTH
CFT 330-1375	.330"	1.375"
CFT 1000-1000	1"	1"
CFT 1250-2000	1.250"	2"
CFT 625-4000	.625"	4"







# TERMINATION TRIMS

- DRYWALL F-MOLD
- DRYWALL SHADOW MOLD
- DRYWALL T-MOLD
- W-TRANSITION MOLD
- DRYWALL L-METAL
- REVERSE L-METAL
- DRYWALL END ENCLOSURE
- DRYWALL GLAZING TRACK
- VENEER PLASTER J-MOLD
- DRYWALL PROTRUSION EDGE TRIM

# DRYWALL F-MOLD

## TRIM PURPOSE

Flannery's Drywall F-Molds create an aesthetic division between drywall and dissimilar materials including door and window frames, ceilings, and floors. Drywall F-Molds can be used to terminate drywall at the top or bottom of vertical walls. It can also be used with gypsum board ceilings. Flannery offers many of its Drywall F-Molds with Aluminum Alignment Splices to ease the installation process and create crisp and clean butt joints and lines.

## SPECIFICATIONS

Flannery's Aluminum Drywall Trims are standard extruded aluminum alloy 6063 T5 and have .050" nominal wall thickness. Drywall trims come in 10' lengths and shall have a standard Mill Finish (for field priming & painting) or a Clear Anodized Finish. Other factory finishes and custom paint orders, including Chem-film or Primer, are available.

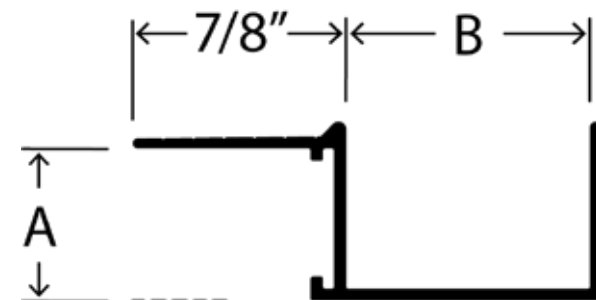
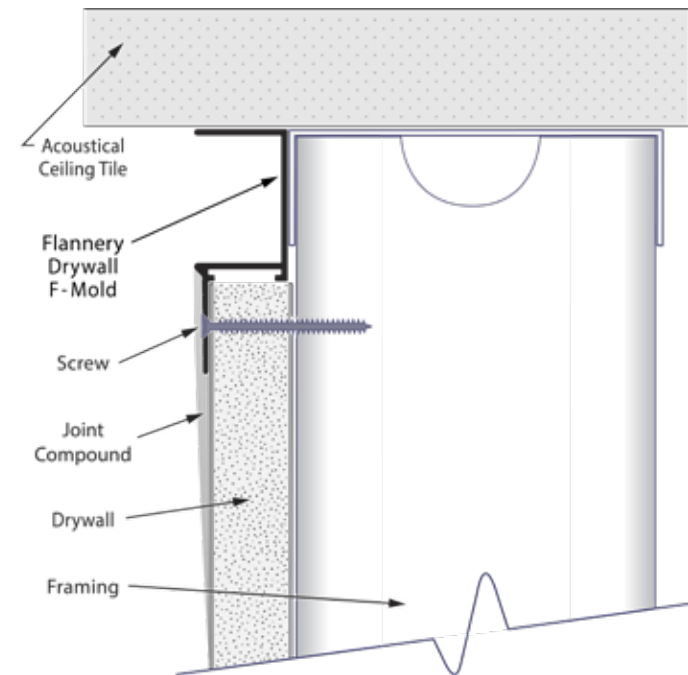

## PRODUCT CHART

PART NO.	"A" DEPTH	"B" WIDTH	VENTING AVAILABLE
DWRF 375-375*	3/8"	3/8"	N/A
DWRF 50-125*	1/2"	1/8"	N/A
DWRF 50-25	1/2"	1/4"	N/A
DWRF 50-375	1/2"	3/8"	N/A
DWRF 50-50	1/2"	1/2"	YES
DWRF 50-75	1/2"	3/4"	YES
DWRF 50-100	1/2"	1"	YES
DWRF 50-150	1/2"	1 1/2"	YES
DWRF 50-200	1/2"	2"	YES
DWRF 50-300*	1/2"	3"	YES
DWRF 50-600*	1/2"	6"	YES
DWRF 625-25	5/8"	1/4"	N/A
DWRF 625-375	5/8"	3/8"	N/A
DWRF 625-50	5/8"	1/2"	YES
DWRF 625-625	5/8"	5/8"	YES
DWRF 625-75	5/8"	3/4"	YES
DWRF 625-100	5/8"	1"	YES
DWRF 625-150	5/8"	1 1/2"	YES
DWRF 625-200	5/8"	2"	YES
DWRF 625-300*	5/8"	3"	YES
DWRF 625-400*	5/8"	4"	YES

\*Indicates a modified part

# DRYWALL SHADOW MOLD

## TRIM PURPOSE

Flannery's Aluminum Drywall Shadow Molds (or Z-Metals) create an aesthetic reveal between drywall and dissimilar materials including door and window frames, ceilings, and floors. Shadow Molds can be used to terminate drywall at the top or bottom of vertical walls. Shadow Molds can also be inserted into Kerf slots along door and window frames. Flannery offers many of its Drywall Shadow Molds with Aluminum Alignment Splices to ease the installation process and create crisp and clean butt joints and lines.

## SPECIFICATIONS

Flannery's Aluminum Drywall Trims are standard extruded aluminum alloy 6063 T5 and have .050" nominal wall thickness. Drywall trims come in 10' lengths and shall have a standard Mill Finish (for field priming & painting) or a Clear Anodized Finish. Other factory finishes and custom paint orders, including Chem-film or Primer, are available.

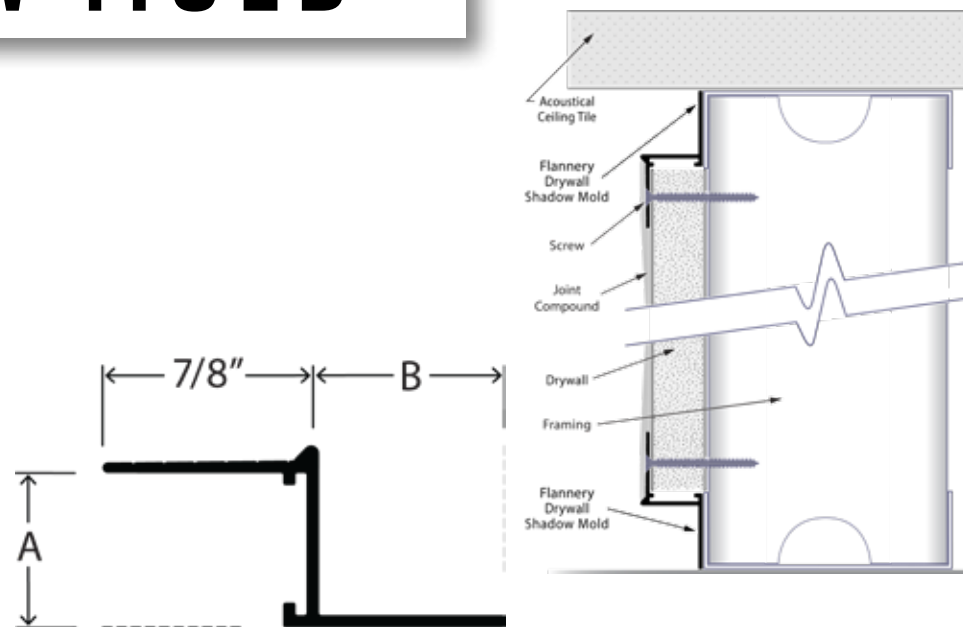

## PRODUCT CHART

PART NO.	"A" DEPTH	"B" WIDTH	VENTING AVAILABLE
DWSM 25-25	1/4"	1/4"	N/A
DWSM 25-75	1/4"	3/4"	N/A
DWSM 375-375	3/8"	3/8"	N/A
DWSM 50-25	1/2"	1/4"	N/A
DWSM 50-375	1/2"	3/8"	N/A
DWSM 50-50	1/2"	1/2"	YES
DWSM 50-625	1/2"	5/8"	YES



## PRODUCT CHART

PART NO.	"A" DEPTH	"B" WIDTH	VENTING AVAILABLE
DWSM 50-75	1/2"	3/4"	YES
DWSM 50-100	1/2"	1"	YES
DWSM 50-150	1/2"	1 1/2"	YES
DWSM 50-200	1/2"	2"	YES
DWSM 50-300*	1/2"	3"	YES
DWSM 50-400*	1/2"	4"	YES
DWSM 50-600*	1/2"	6"	YES
DWSM 625-25	5/8"	1/4"	N/A
DWSM 625-375	5/8"	3/8"	N/A
DWSM 625-50	5/8"	1/2"	YES
DWSM 625-625	5/8"	5/8"	YES
DWSM 625-75	5/8"	3/4"	YES
DWSM 625-100	5/8"	1"	YES
DWSM 625-1250	5/8"	1 1/4"	YES
DWSM 625-150	5/8"	1 1/2"	YES
DWSM 625-200	5/8"	2"	YES
DWSM 625-250	5/8"	2 1/2"	YES
DWSM 625-300	5/8"	3"	YES
DWSM 625-350*	5/8"	3 1/2"	YES
DWSM 625-400	5/8"	4"	YES
DWSM 625-600	5/8"	6"	YES
DWSM 100-100	1"	1"	N/A

\*Indicates a modified part

# DRYWALL T-MOLD

## TRIM PURPOSE

Flannery's Drywall T-Mold is a base-of-wall trim that allows the installer to attach it to the framing prior to the installation of the gypsum board without losing the advantage of being able to tape and mud the trim to the drywall. Drywall T-Molds create the same aesthetic reveal between drywall and dissimilar materials that an Aluminum Drywall Shadow Mold would, with the advantage of setting the trim in place first.

## SPECIFICATIONS

Flannery's Aluminum Drywall Trims are standard extruded aluminum alloy 6063 T5 and have .050" nominal wall thickness. Drywall trims come in 10' lengths and shall have a standard Mill Finish (for field priming & painting) or a Clear Anodized Finish. Other factory finishes and custom paint orders, including Chem-film or Primer, are available.

## PRODUCT CHART

PART NO.	"A" DEPTH	"B" WIDTH
DWT 625-150	5/8"	1 1/2"

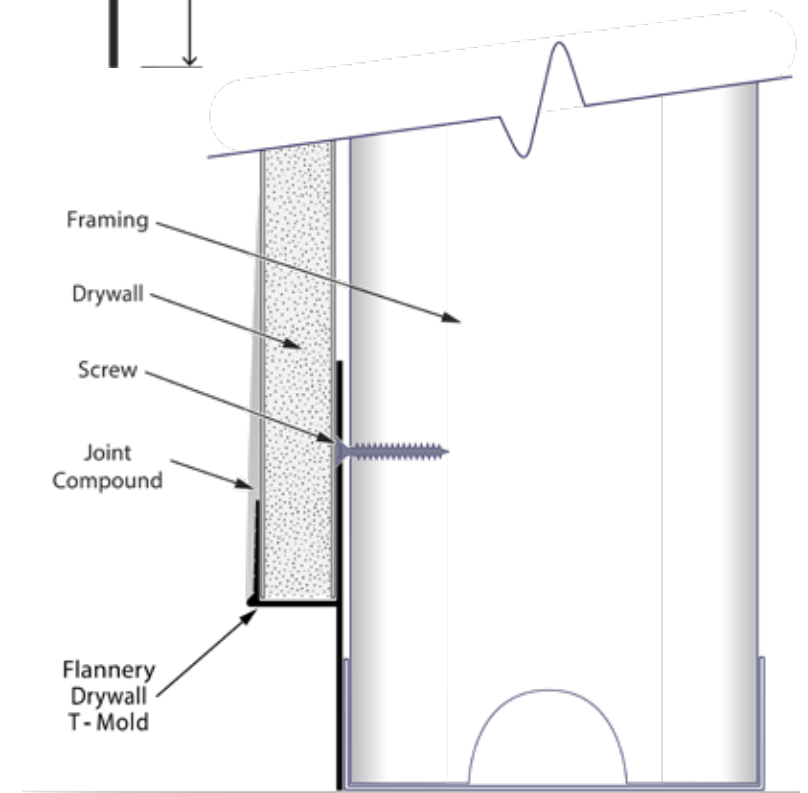
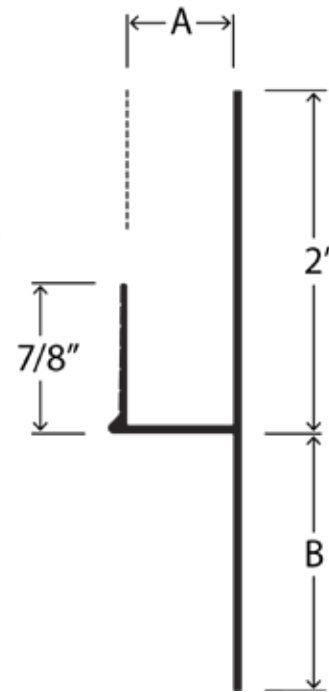

# W-TRANSITION MOLD

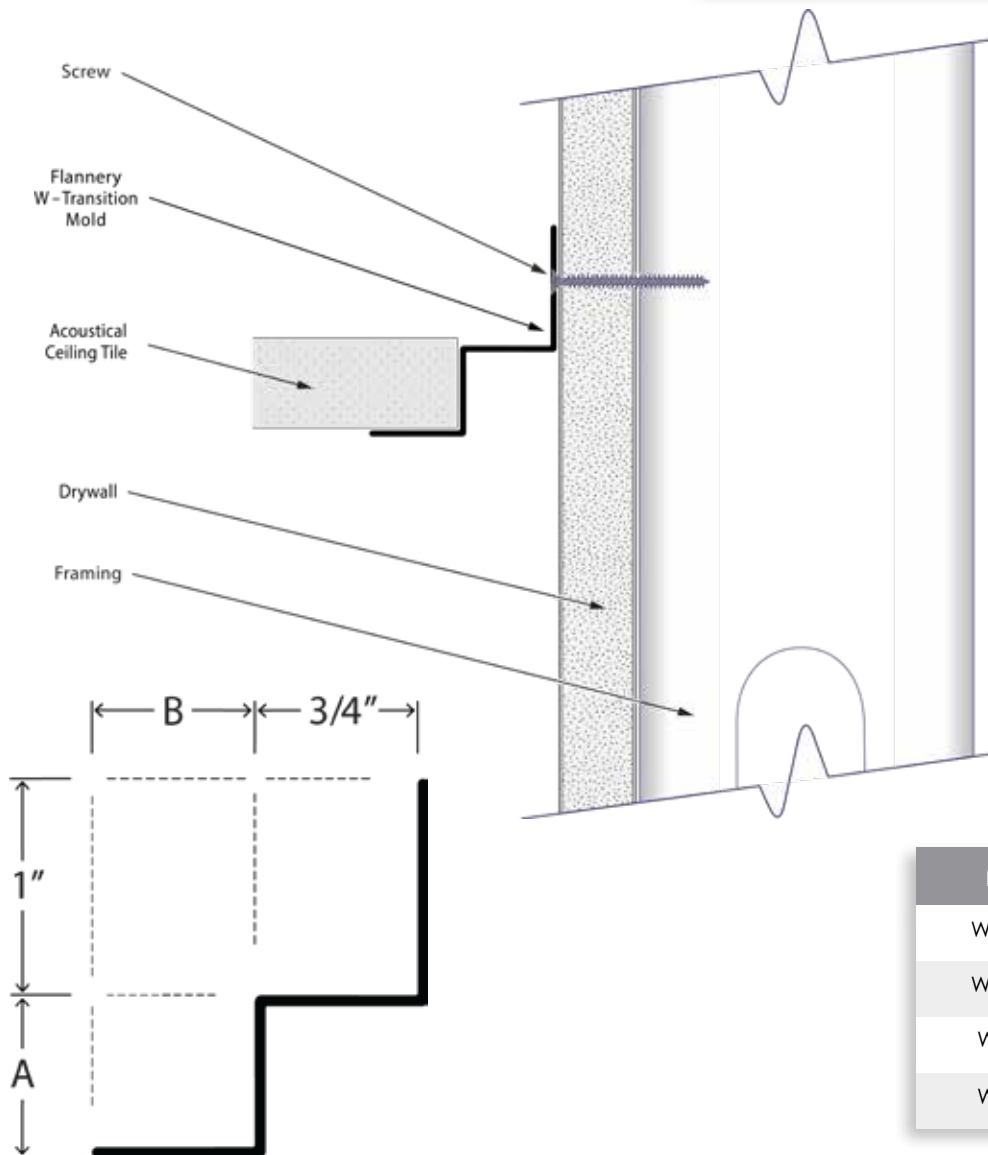

800.765.7585

## TRIM PURPOSE

Flannery's W-Transition Mold is an Aluminum trim which allows for transitions between vertical walls and ceilings. It can also be used to form a reveal between a wall and a suspended ceiling. Many of the W-Transition Molds can be ventilated to allow air-flow up into a recessed soffit.

## SPECIFICATIONS

Flannery's Aluminum Drywall Trims are standard extruded aluminum alloy 6063 T5 and have .050" nominal wall thickness. Drywall trims come in 10' lengths and shall have a standard Mill Finish (for field priming & painting) or a Clear Anodized Finish. Other factory finishes and custom paint orders, including Chem-film or Primer, are available.

## PRODUCT CHART

PART NO.	"A" WIDTH	"B" WIDTH	VENTING AVAILABLE
WTM 75-050	3/4"	1/20"	YES
WTM 75-187	3/4"	3/16"	YES
WTM 75-50	3/4"	1/2"	N/A
WTM 75-75	3/4"	3/4"	N/A



# DRYWALL L-METAL

## TRIM PURPOSE

Flannery's Aluminum Drywall L-Metals create a termination to drywall wherever it may finish against a dissimilar material. L-Metals cover the unfinished edge of drywall to allow for a smooth and clean transition from drywall to drywall or drywall to another material. It can also be used around inset doors and windows to create an "aluminum sill."

## SPECIFICATIONS

Flannery's Aluminum Drywall Trims are standard extruded aluminum alloy 6063 T5 and have .050" nominal wall thickness. Drywall trims come in 10' lengths and shall have a standard Mill Finish (for field priming & painting) or a Clear Anodized Finish. Other factory finishes and custom paint orders, including Chem-film or Primer, are available.

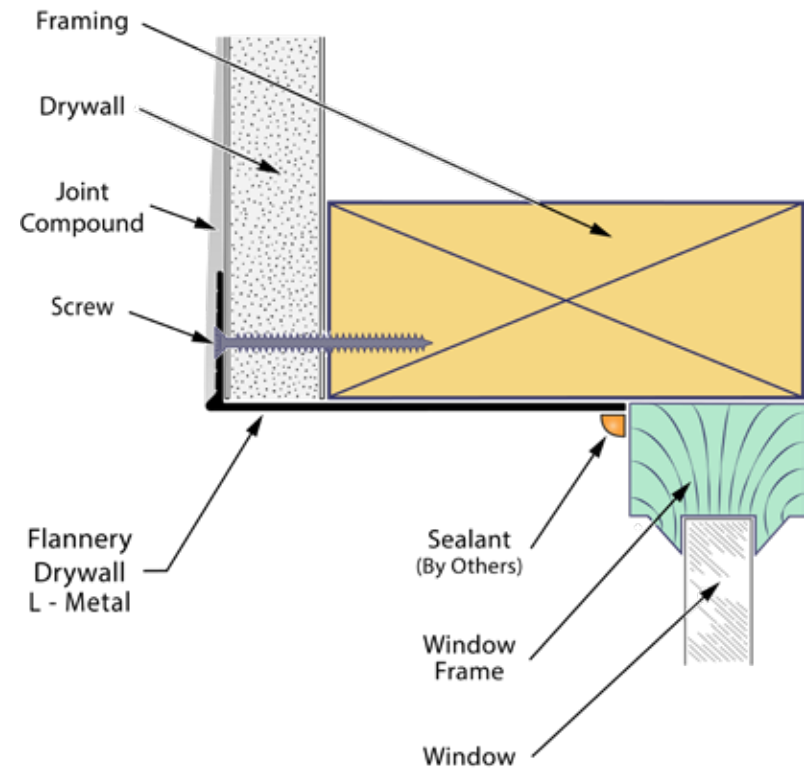

## PRODUCT CHART

PART NO.	"A" WIDTH
DWL 25*	¼"
DWL 375*	⅜"
DWL 50	½"
DWL 625	⅝"
DWL 75	¾"
DWL 875*	⅞"
DWL 100	1"
DWL 1250	1 ¼"
DWL 150	1 ½"
DWL 1625*	1 ⅝"
DWL 200	2"
DWL 250*	2 ½"
DWL 2625	2 ⅝"
DWL 300*	3"
DWL 350*	3 ½"
DWL 400*	4"
DWL 450*	4 ½"
DWL 500*	5"
DWL 600*	6"
DWL 700*	7"

\*Indicates a modified part.  
Custom Sizes available up  
to 7 ¼".



# REVERSE L METAL

## TRIM PURPOSE

Flannery's Reverse L-Metals create a termination to drywall wherever it may finish against a perpendicular plane that may not allow for joint compound to be applied. Reverse L-Metals cover the unfinished edge of drywall to allow for a smooth and clean transition from drywall to drywall or drywall to another material. It can also be used where a drywall ceiling transitions to a vertical wall with wallpaper or paneling.

## SPECIFICATIONS

Flannery's Aluminum Drywall Trims are standard extruded aluminum alloy 6063 T5 and have .050" nominal wall thickness. Drywall trims come in 10' lengths and shall have a standard Mill Finish (for field priming & painting) or a Clear Anodized Finish. Other factory finishes and custom paint orders, including Chem-film or Primer, are available.

## PRODUCT CHART

PART NO.	"A" WIDTH
DWRLM 50	1/2"
DWRLM 625	5/8"
DWRLM 75	3/4"
DWRLM 100	1"

PART NO.	"A" WIDTH
DWRLM 150	1 1/2"
DWRLM 200	2"
DWRLM 300	3"
DWRLM 400	4"

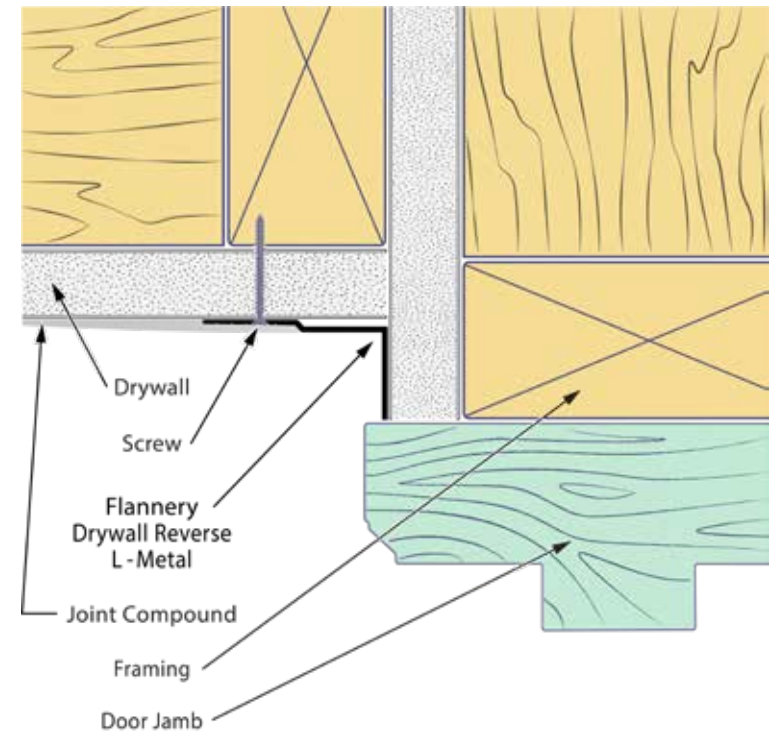
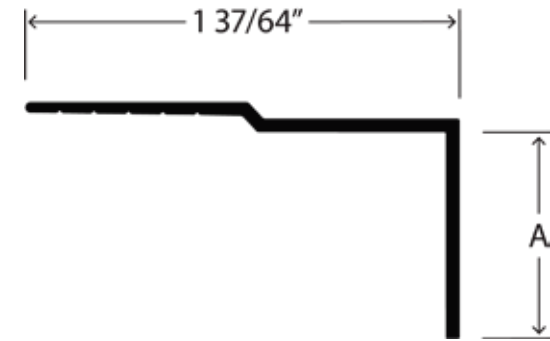



# DRYWALL END ENCLOSURE

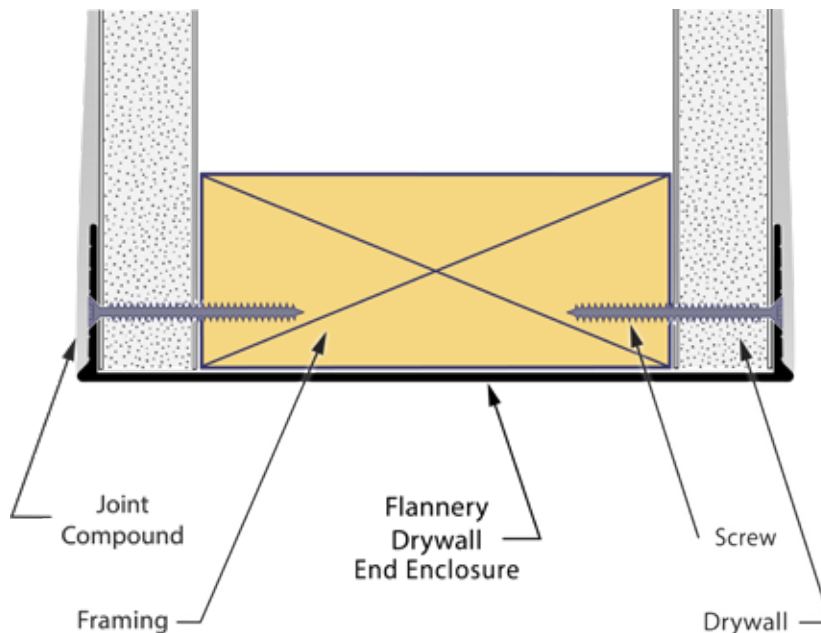
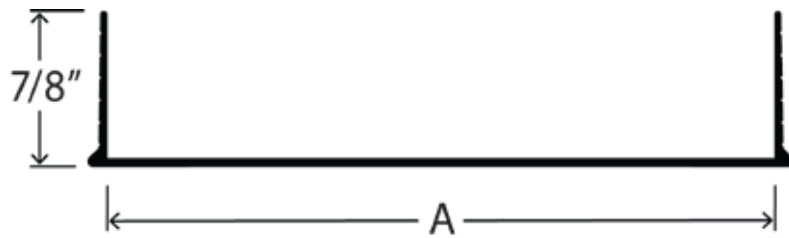

## TRIM PURPOSE

Flannery's Aluminum Drywall End Enclosures help terminate walls, partitions or cased openings. End Enclosures can be used to cap the edges of "door-less" wall openings or where a wall might terminate against a window. End Enclosures completely encapsulate a stud and two layers of gypsum board.

## SPECIFICATIONS

Flannery's Aluminum Drywall Trims are standard extruded aluminum alloy 6063 T5 and have .050" nominal wall thickness. Drywall trims come in 10' lengths and shall have a standard Mill Finish (for field priming & painting) or a Clear Anodized Finish. Other factory finishes and custom paint orders, including Chem-film or Primer, are available.

## PRODUCT CHART

PART NO.	"A" WIDTH
DWE 3750	3 3/4"
DWE 4875	4 7/8"
DWE 7250	7 1/4"

# DRYWALL GLAZING TRACK

## TRIM PURPOSE

Flannery's Drywall Glazing Track helps terminate a wall and frame a window within an interior partition wall or cased opening. Glazing Tracks are used in conjunction with a piece of rubber (provided by others) to allow for the installation of a piece of glass. Glazing Tracks completely encapsulate a stud and two layers of gypsum board.

## SPECIFICATIONS

Flannery's Aluminum Drywall Trims are standard extruded aluminum alloy 6063 T5 and have .050" nominal wall thickness. Drywall trims come in 10' lengths and shall have a standard Mill Finish (for field priming & painting) or a Clear Anodized Finish. Other factory finishes and custom paint orders, including Chem-film or Primer, are available.

## PRODUCT CHART

PART NO.	"A" WIDTH
DWGT 4875	4 7/8"

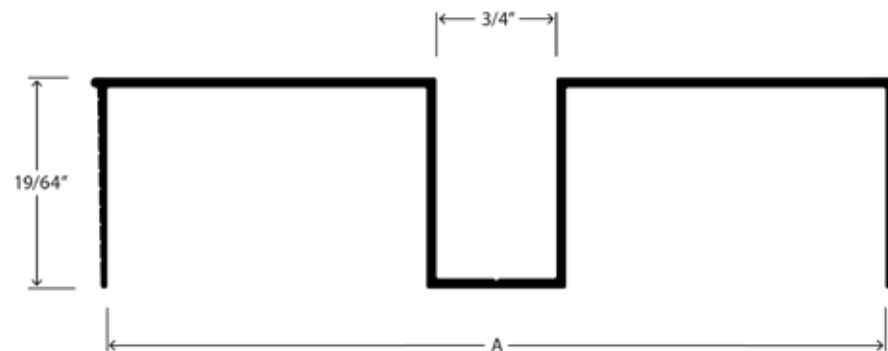
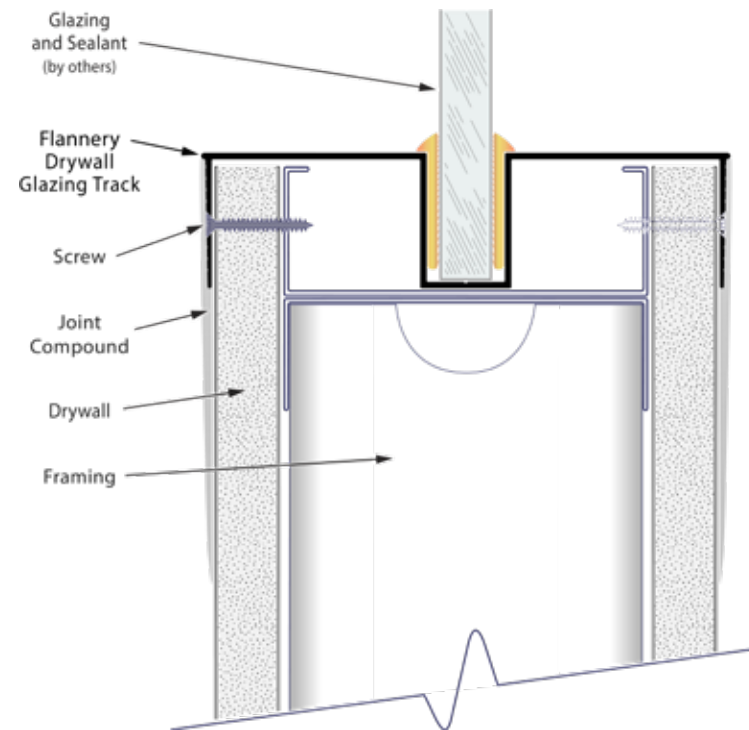

# VENEER PLASTER J-MOLD

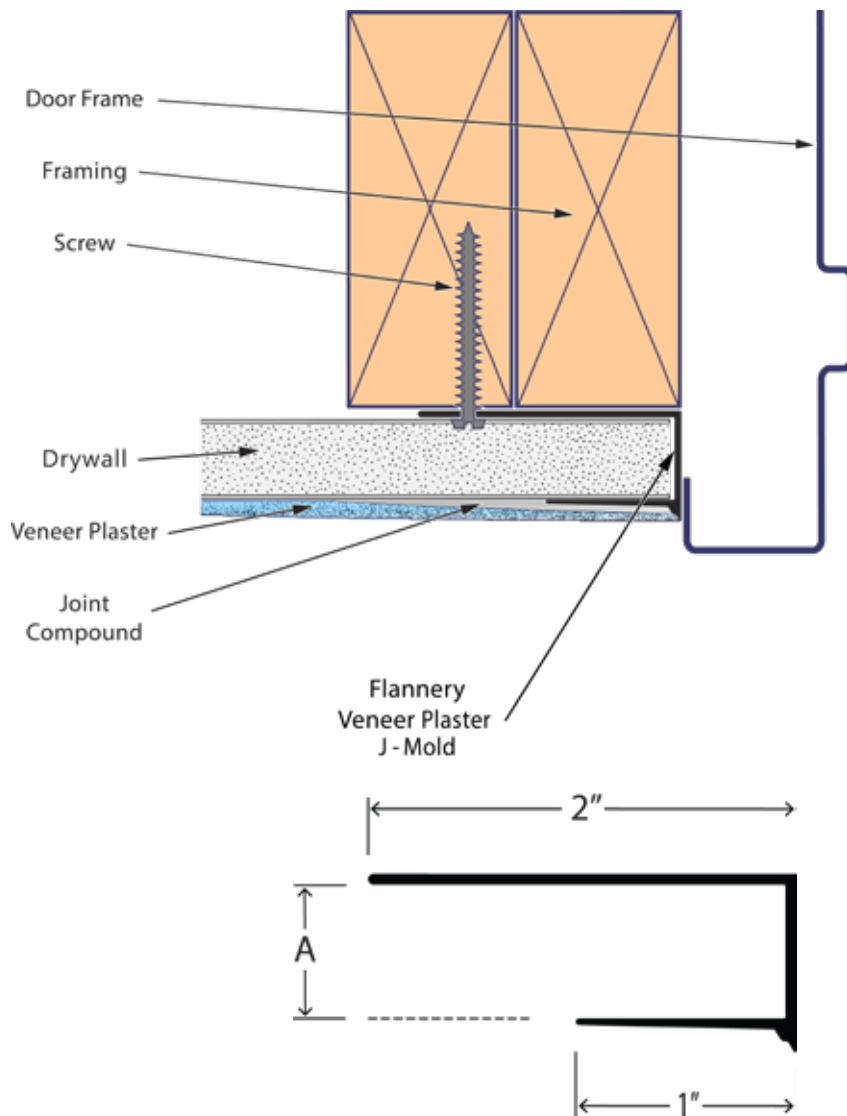

## TRIM PURPOSE

Flannery's Veneer Plaster J-Mold is an edge trim that allows the installer to attach it to the framing prior to the installation of the gypsum board without losing the advantage of being able to tape and mud the trim to the drywall. Most commonly known as "Drywall J-Bead", the Veneer Plaster J-Mold offers an even greater bevel for joint compound than typical drywall trims provide. This additional bevel to the taping flange allows for the application of the veneer plaster for a clean and crisp edge to the wall system.

## SPECIFICATIONS

Flannery's Aluminum Drywall Trims are standard extruded aluminum alloy 6063 T5 and have .050" nominal wall thickness. Drywall trims come in 10' lengths and shall have a standard Mill Finish (for field priming & painting) or a Clear Anodized Finish. Other factory finishes and custom paint orders, including Chem-film or Primer, are available.

## PRODUCT CHART

PART NO.	"A" WIDTH
VPJ 625	5/8"



# DRYWALL PROTRUSION EDGE TRIM

## TRIM PURPOSE

Flannery's Drywall Protrusion Edge Trim creates a termination to drywall and has a protruding decorative reveal that sits at the edge of the trim. Protrusion Edge Trims cover the unfinished edge of drywall to allow for a smooth and clean transition to an inset window or door.

## SPECIFICATIONS

Flannery's Aluminum Drywall Trims are standard extruded aluminum alloy 6063 T5 and have .050" nominal wall thickness. Drywall trims come in 10' lengths and shall have a standard Mill Finish (for field priming & painting) or a Clear Anodized Finish. Other factory finishes and custom paint orders, including Chem-film or Primer, are available.

## PRODUCT CHART

PART NO.	"A" WIDTH
DWPET 100	1"
DWPET 150	1 1/2"

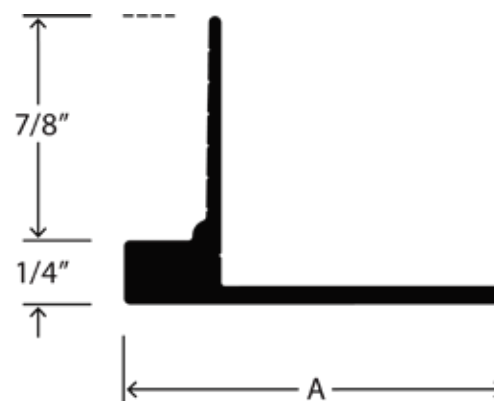
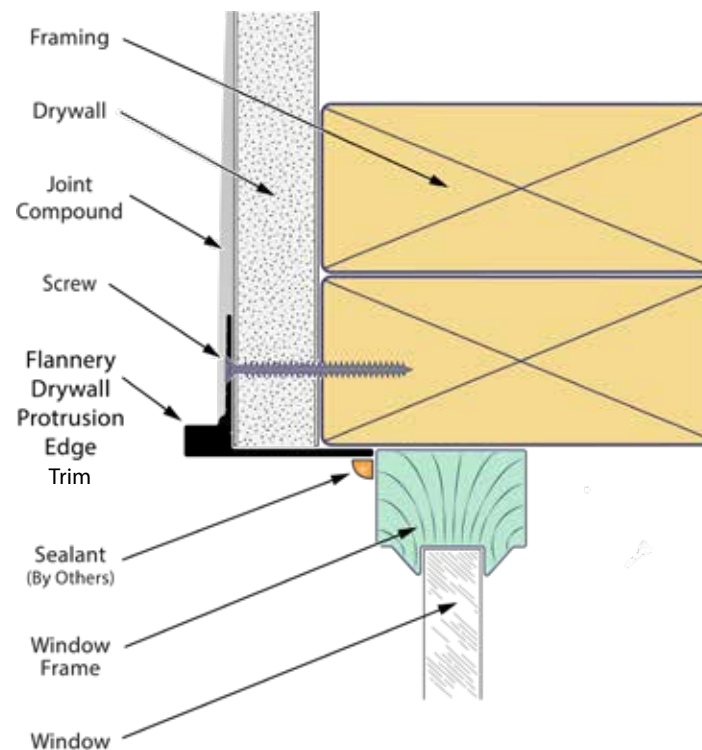



# CORNER TRIMS

- DRYWALL REVEAL CORNER
- DRYWALL OUTSIDE CORNER
- BEVELED DRYWALL CORNER
- DRYWALL PROTRUSION EDGE CORNER

# DRYWALL REVEAL CORNER

## TRIM PURPOSE

Flannery's Drywall Corner Reveal is an aluminum trim for outside corners of drywall. The Drywall Corner Reveal creates a "stepped" reveal look where two walls of drywall meet. Once drywall mud and tape is applied to the attachment flanges the outside corner has the appearance of a reveal instead of the conventional sharp cornerbead look.

## SPECIFICATIONS

Flannery's Aluminum Drywall Trims are standard extruded aluminum alloy 6063 T5 and have .050" nominal wall thickness. Drywall trims come in 10' lengths and shall have a standard Mill Finish (for field priming & painting) or a Clear Anodized Finish. Other factory finishes and custom paint orders, including Chem-film or Primer, are available.

## PRODUCT CHART

PART NO.	"A" WIDTH	"B" WIDTH
DWRW 50-50	1/2"	1/2"
DWRW 625-625	5/8"	5/8"
DWRW 100-100	1"	1"

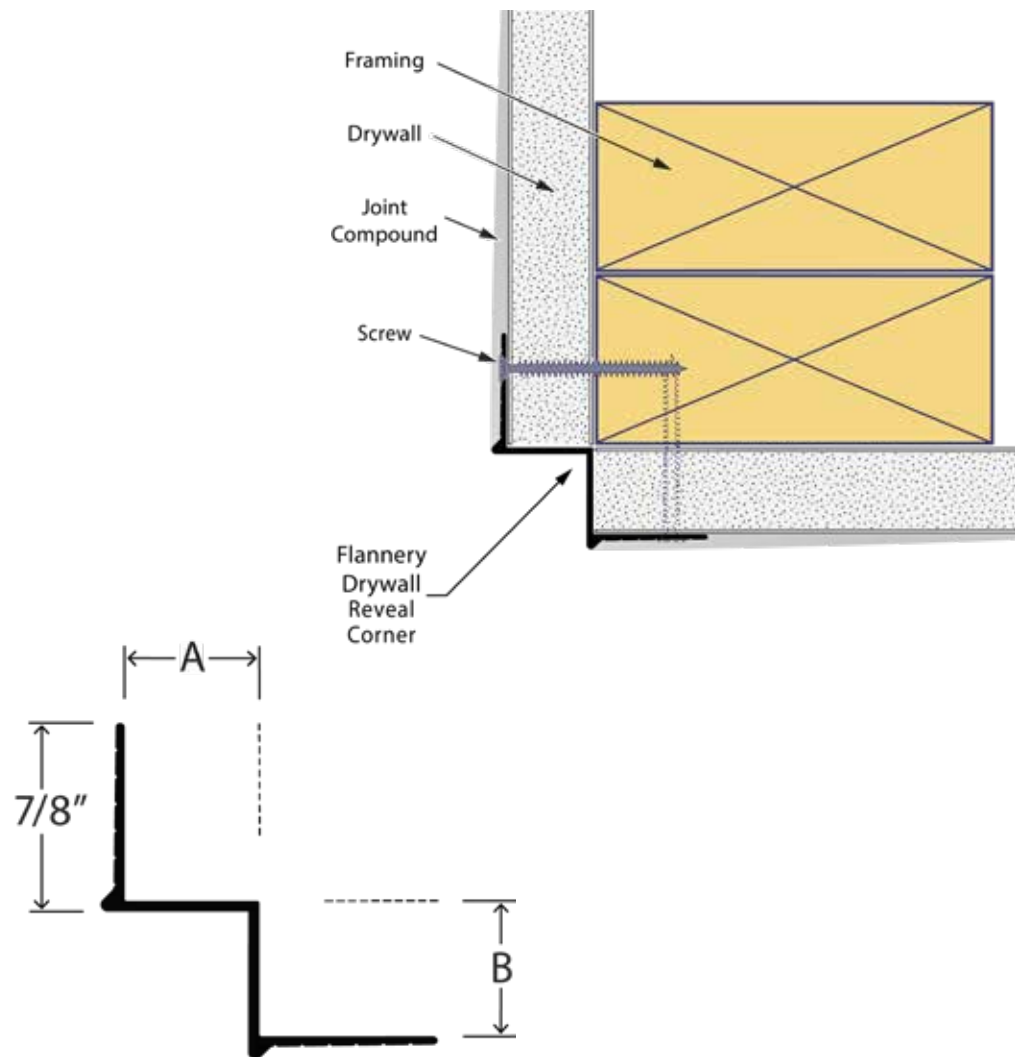



# DRYWALL OUTSIDE CORNER

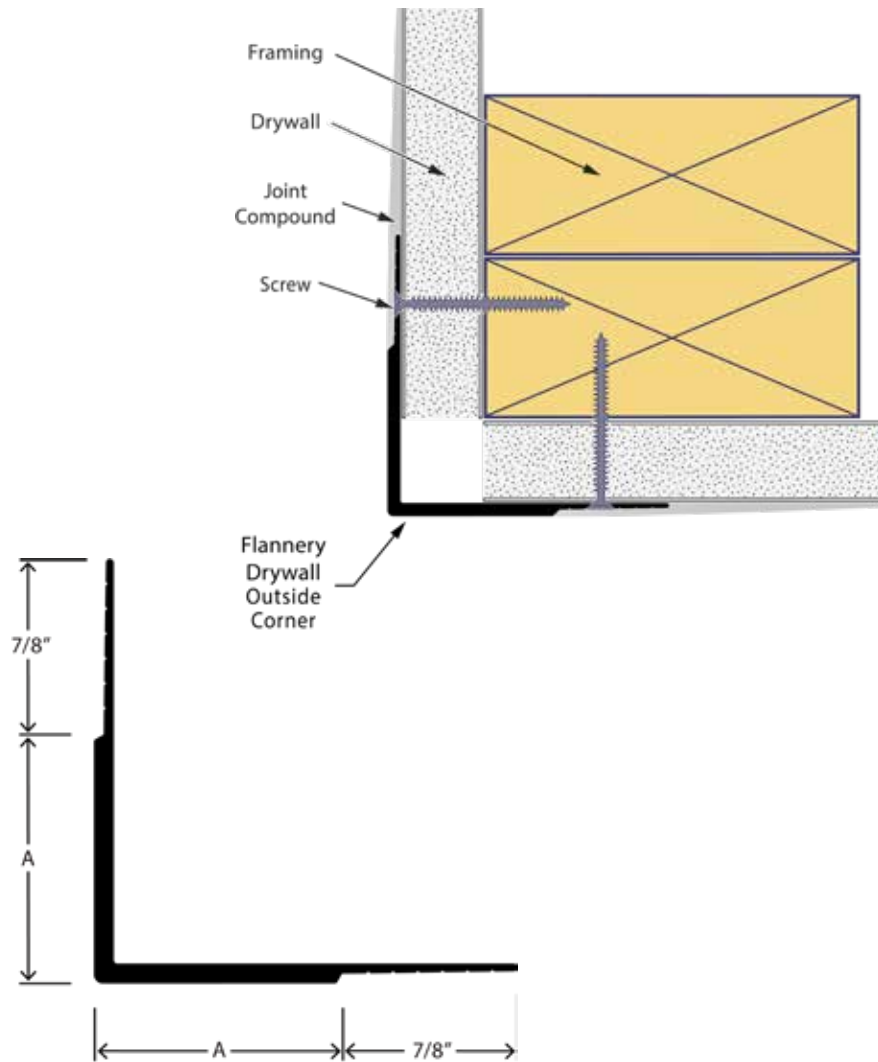

## TRIM PURPOSE

Flannery's Aluminum Drywall Outside Corner is a high strength alternative to galvanized or plastic square corner bead. Its thickness allows it to be utilized in high traffic areas where outside drywall corners may require additional protection than the conventional cornerbead.

## SPECIFICATIONS

Flannery's Aluminum Drywall Trims are standard extruded aluminum alloy 6063 T5 and have .050" nominal wall thickness. Drywall trims come in 10' lengths and shall have a standard Mill Finish (for field priming & painting) or a Clear Anodized Finish. Other factory finishes and custom paint orders, including Chem-film or Primer, are available.

## PRODUCT CHART

PART NO.	"A" WIDTH
DOC 375	3/8"
DOC 1250	1 1/4"

# BEVELED DRYWALL CORNER

## TRIM PURPOSE

Flannery's Aluminum Beveled Drywall Corner is a unique outside corner trim that provides both a sturdy and aesthetic corner effect. The "chamfered" or "flat-nosed" Beveled Drywall Corner can be utilized with any thickness of drywall.

## SPECIFICATIONS

Flannery's Aluminum Drywall Trims are standard extruded aluminum alloy 6063 T5 and have .050" nominal wall thickness. Drywall trims come in 10' lengths and shall have a standard Mill Finish (for field priming & painting) or a Clear Anodized Finish. Other factory finishes and custom paint orders, including Chem-film or Primer, are available.

## PRODUCT CHART

PART NO.

BDC

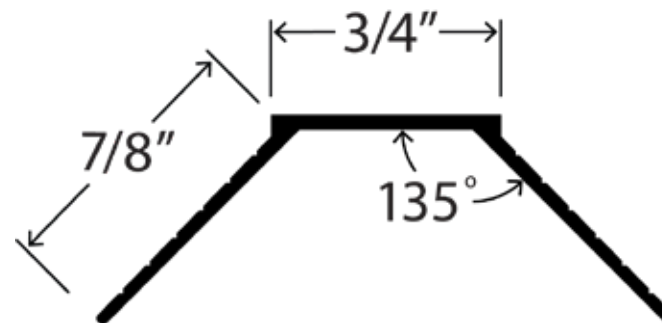
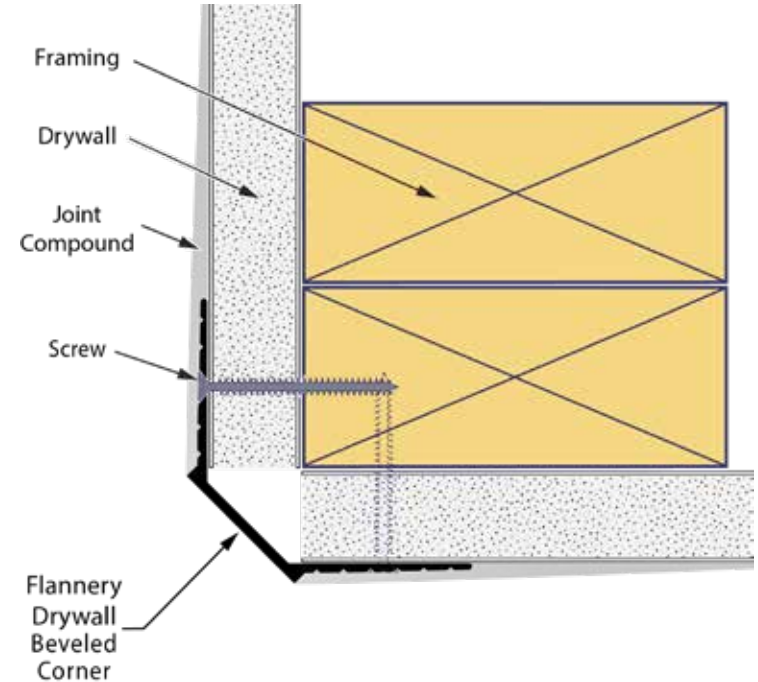

# DRYWALL PROTRUSION EDGE CORNER

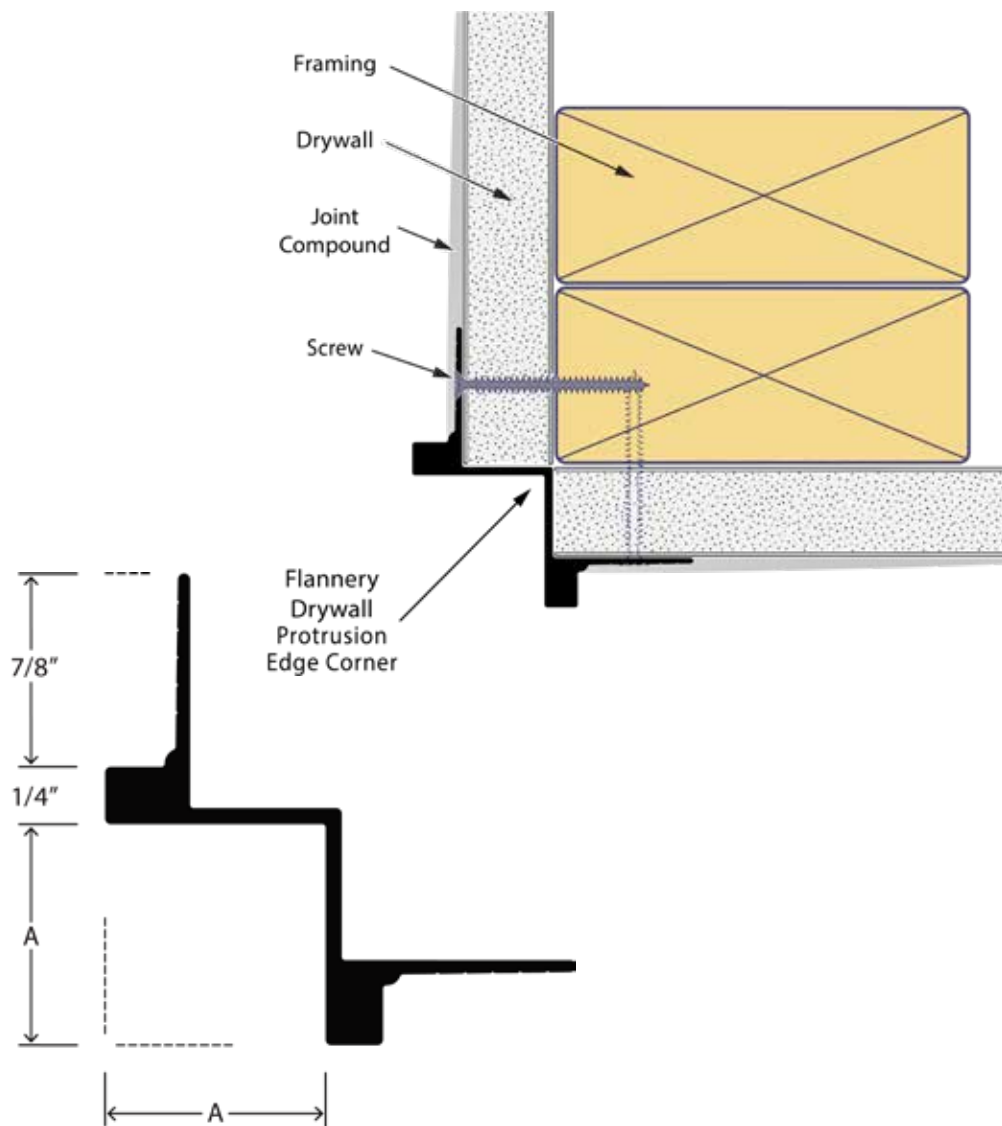

800.765.7585

## TRIM PURPOSE

Flannery's Drywall Protrusion Edge Corner is an aluminum trim for outside corners of drywall and has a protruding decorative reveal. The Protrusion Edge Corner creates a "stepped" reveal look where two walls of drywall meet. Once drywall mud and tape is applied to the attachment flanges the Edge Corner has the appearance of a decorative reveal at an outside corner instead of the conventional sharp cornerbead look.

## SPECIFICATIONS

Flannery's Aluminum Drywall Trims are standard extruded aluminum alloy 6063 T5 and have .050" nominal wall thickness. Drywall trims come in 10' lengths and shall have a standard Mill Finish (for field priming & painting) or a Clear Anodized Finish. Other factory finishes and custom paint orders, including Chem-film or Primer, are available.

## PRODUCT CHART

PART NO.	"A" DEPTH
DWPEC 100-100	1"





# LED TRIMS

- LED DRYWALL REVEAL
- LED DRYWALL HOUSING MOLD
- LED BASE MOLDING
- LED CEILING MOLD
- LED DRYWALL POCKET TRIM
- LED PANEL SCREED
- LED FLUSH SCREED

# LED DRYWALL REVEAL

## TRIM PURPOSE

Flannery's LED Drywall Reveal (LDR) trim creates a linear light reveal between drywall panels on vertical walls or ceilings. The LED Drywall Reveal can be installed with either  $\frac{1}{2}$ " or  $\frac{5}{8}$ " thick gypsum board and has thinning mud flanges to allow the installer to finish it to drywall. Flannery's LED Drywall Reveal comes with a frosted diffuser and allows for a  $\frac{1}{2}$ " wide or smaller LED strip to be applied to the aluminum reveal (LED's and wiring are not provided).

## SPECIFICATIONS

Flannery's LED Trims are standard extruded aluminum alloy 6063 T5 and have a .050" nominal wall thickness. LED Reveals come in 10' lengths and shall have a standard Mill Finish (for field priming & painting) or a Clear Anodized Finish. Other factory finishes and custom paint orders, including Chem-film or Primer, are available.

## PRODUCT CHART

PART NO.	"A" DEPTH	"B" WIDTH
LDR 50-50	$\frac{1}{2}$ "	$\frac{1}{2}$ "

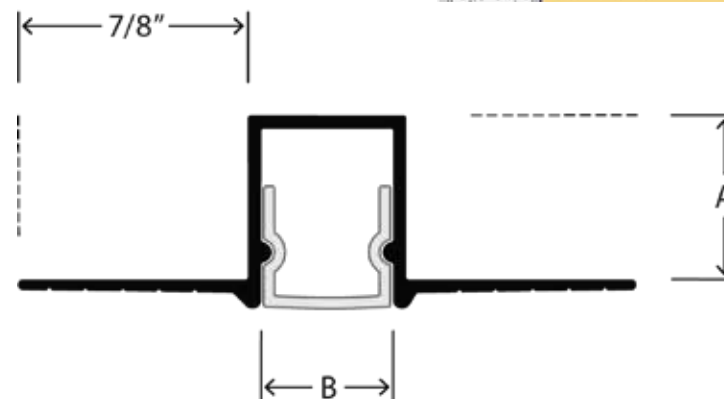
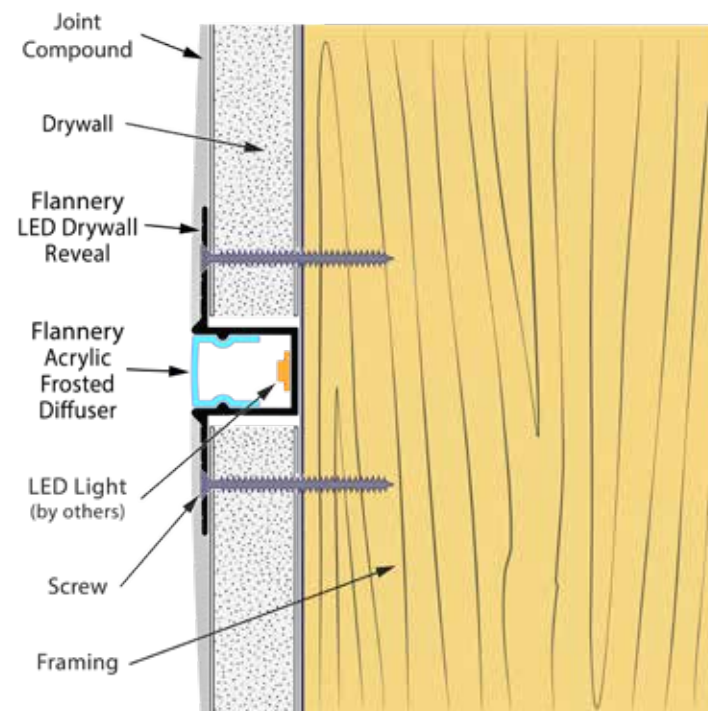



# LED DRYWALL HOUSING MOLD

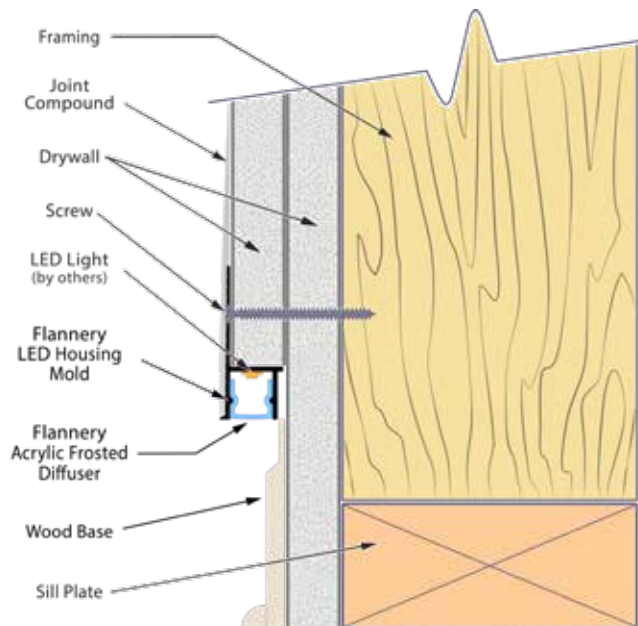
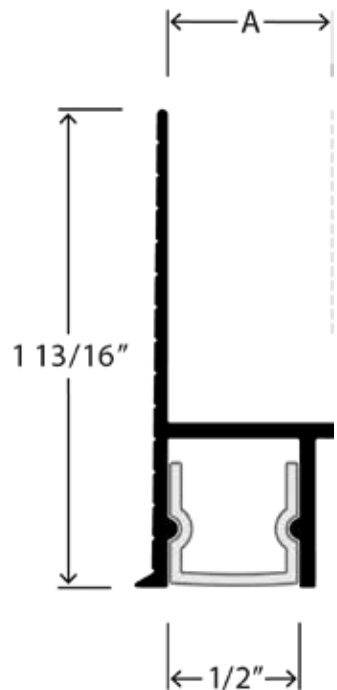

## TRIM PURPOSE

Flannery's LED Drywall Housing Mold (LHM) creates a linear light reveal at the top, bottom or edge of a gypsum wall or ceiling. The Housing Mold is installed with  $\frac{5}{8}$ " thick gypsum board and allows for the insertion of a  $\frac{1}{2}$ " wide LED strip along the edge of any drywall plane to create a light cove. Flannery's LED Housing Mold comes with a frosted diffuser (LED's and wiring are not provided).

## SPECIFICATIONS

Flannery's LED Trims are standard extruded aluminum alloy 6063 T5 and have a .050" nominal wall thickness. LED Reveals come in 10' lengths and shall have a standard Mill Finish (for field priming & painting) or a Clear Anodized Finish. Other factory finishes and custom paint orders, including Chem-film or Primer, are available.

## PRODUCT CHART

PART NO.	"A" DEPTH
LHM 625	$\frac{5}{8}$ "

# LED BASE MOLDING

## TRIM PURPOSE

Flannery's LED Drywall Base Molding (LBM) creates a linear light reveal at the bottom of a vertical gypsum wall. The LED Drywall Base Mold is installed with  $\frac{5}{8}$ " thick gypsum board and is available in varying heights. Flannery's LED Drywall Base Mold comes with a frosted diffuser and allows for a  $\frac{1}{2}$ " wide or smaller LED strip to be applied to the reveal's side wall (LED's and wiring are not provided).

## SPECIFICATIONS

Flannery's LED Trims are standard extruded aluminum alloy 6063 T5 and have a .050" nominal wall thickness. LED Reveals come in 10' lengths and shall have a standard Mill Finish (for field priming & painting) or a Clear Anodized Finish. Other factory finishes and custom paint orders, including Chem-film or Primer, are available.

## PRODUCT CHART

PART NO.	"A" DEPTH	"B" WIDTH
LBM 625-200	$\frac{5}{8}$ "	2"
LBM 625-300	$\frac{5}{8}$ "	3"
LBM 625-400	$\frac{5}{8}$ "	4"

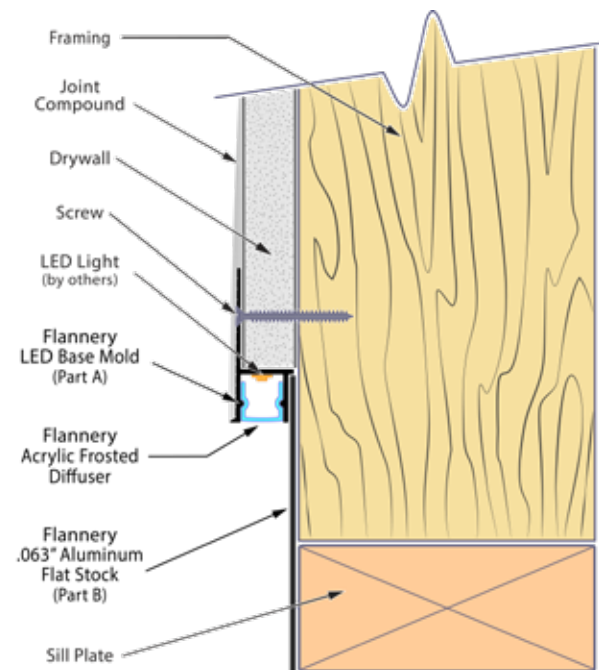
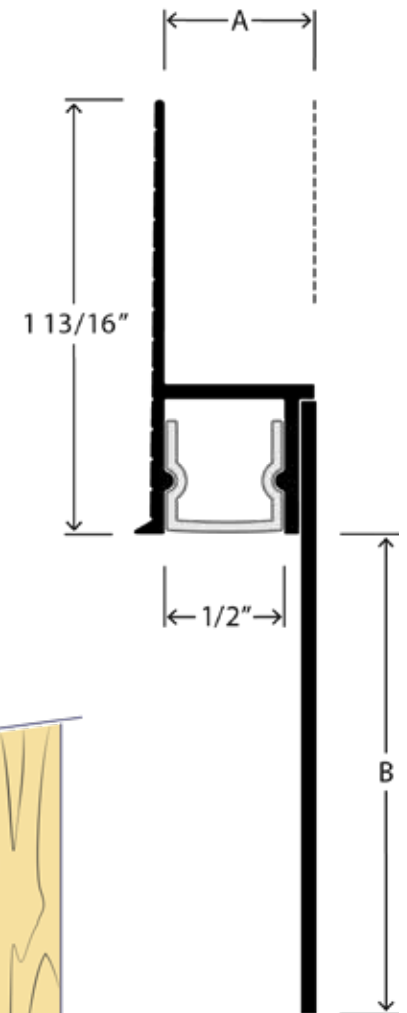

# LED CEILING MOLD

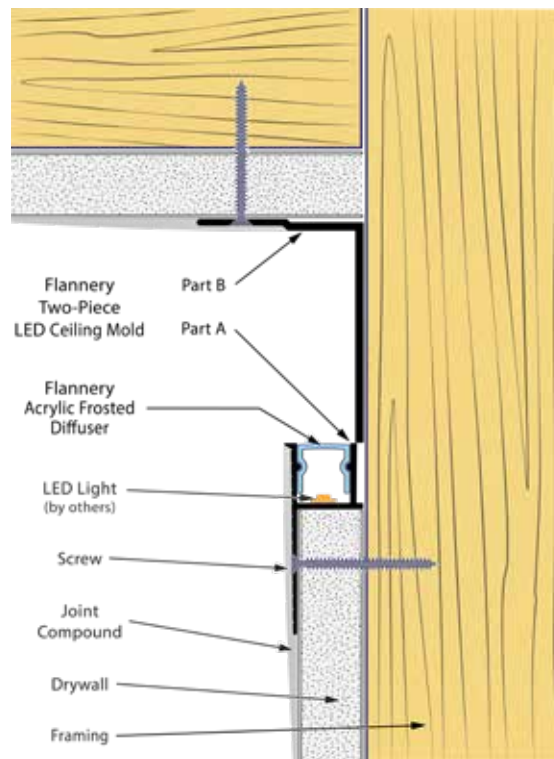
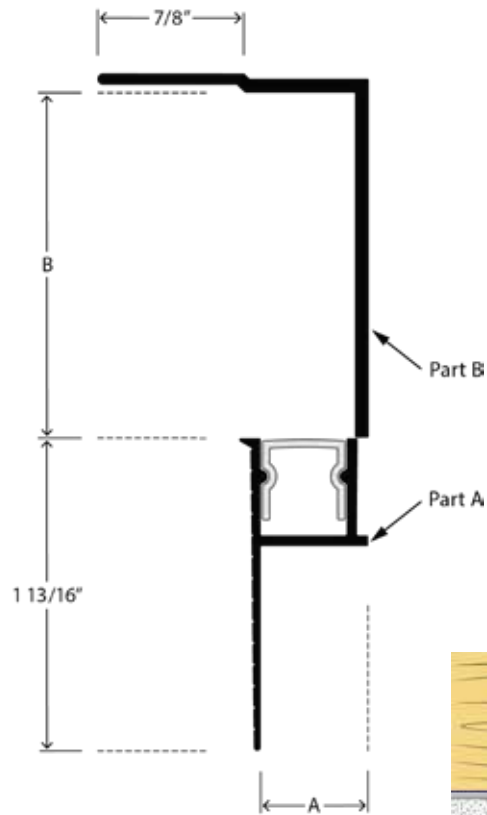

## TRIM PURPOSE

Flannery's LED Drywall Ceiling Mold (LCM) creates a linear light reveal at the top of a vertical gypsum wall where it meets a gypsum board ceiling. The LED Ceiling Trim is installed with  $\frac{5}{8}$ " thick gypsum board and is available in varying heights. Flannery's LED Drywall Ceiling Trim comes with a frosted diffuser and allows for a  $\frac{1}{2}$ " wide or smaller LED strip to be applied to the reveal's side wall (LED's and wiring are not provided).

## SPECIFICATIONS

Flannery's LED Trims are standard extruded aluminum alloy 6063 T5 and have a .050" nominal wall thickness. LED Reveals come in 10' lengths and shall have a standard Mill Finish (for field priming & painting) or a Clear Anodized Finish. Other factory finishes and custom paint orders, including Chem-film or Primer, are available.

## PRODUCT CHART

PART NO.	"A" DEPTH	"B" WIDTH
LCM 625-200	$\frac{5}{8}$ "	2"
LCM 625-300	$\frac{5}{8}$ "	3"
LCM 625-400	$\frac{5}{8}$ "	4"



# LED DRYWALL POCKET TRIM

## TRIM PURPOSE

Flannery's LED Drywall Pocket Trim is a drywall trim that creates a small pocket in a wall or ceiling to allow for the installation of a LED light strip. The LED Drywall Pocket Trim hides the LED light strip from direct view and creates a pocket or return in a gypsum wall or ceiling and can be combined with a flat strip of aluminum or other metal to create a reflective light effect (LED's and wiring are not provided).

## SPECIFICATIONS

Flannery's LED Trims are standard extruded aluminum alloy 6063 T5 and have a .050" nominal wall thickness. LED Reveals come in 10' lengths and shall have a standard Mill Finish (for field priming & painting) or a Clear Anodized Finish. Other factory finishes and custom paint orders, including Chem-film or Primer, are available.

## PRODUCT CHART

PART NO.	"A" DEPTH	"B" WIDTH
FDD 75-1125	¾"	1 ⅛"

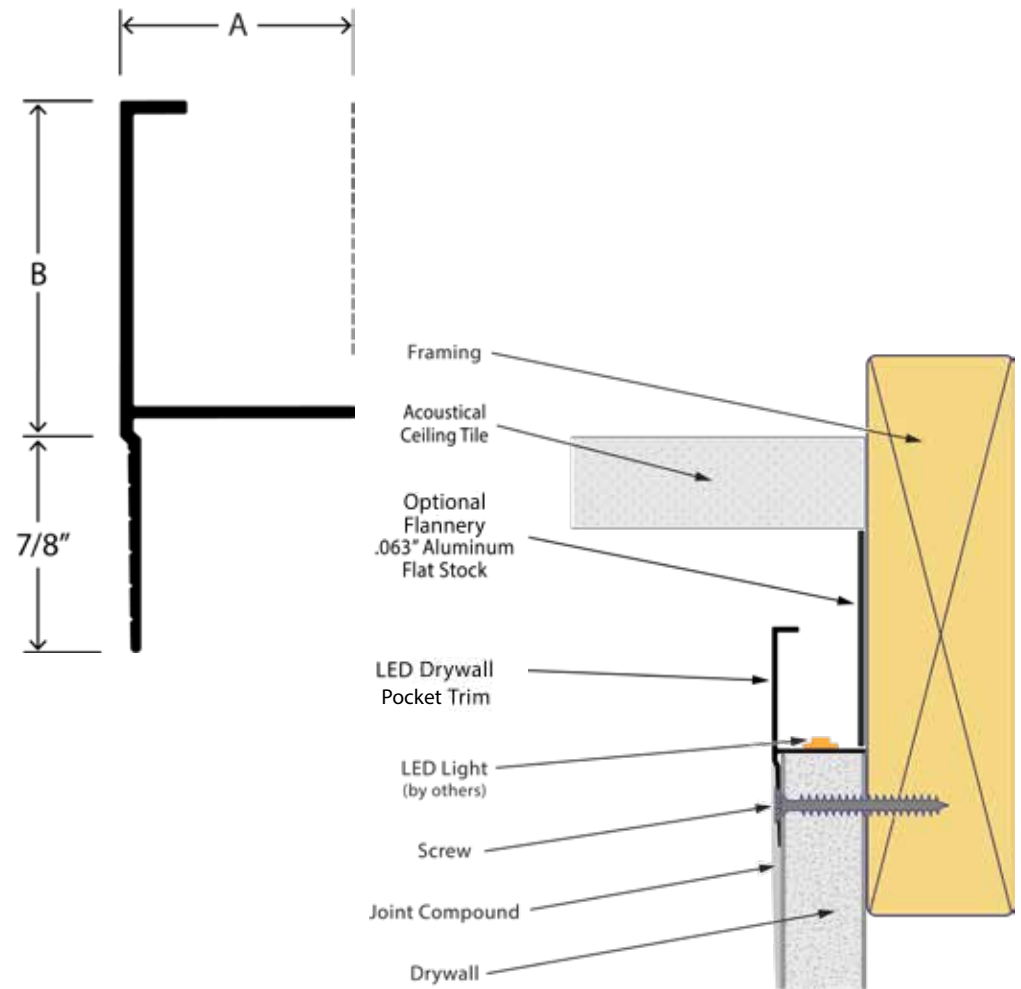

# LED PANEL SCREED

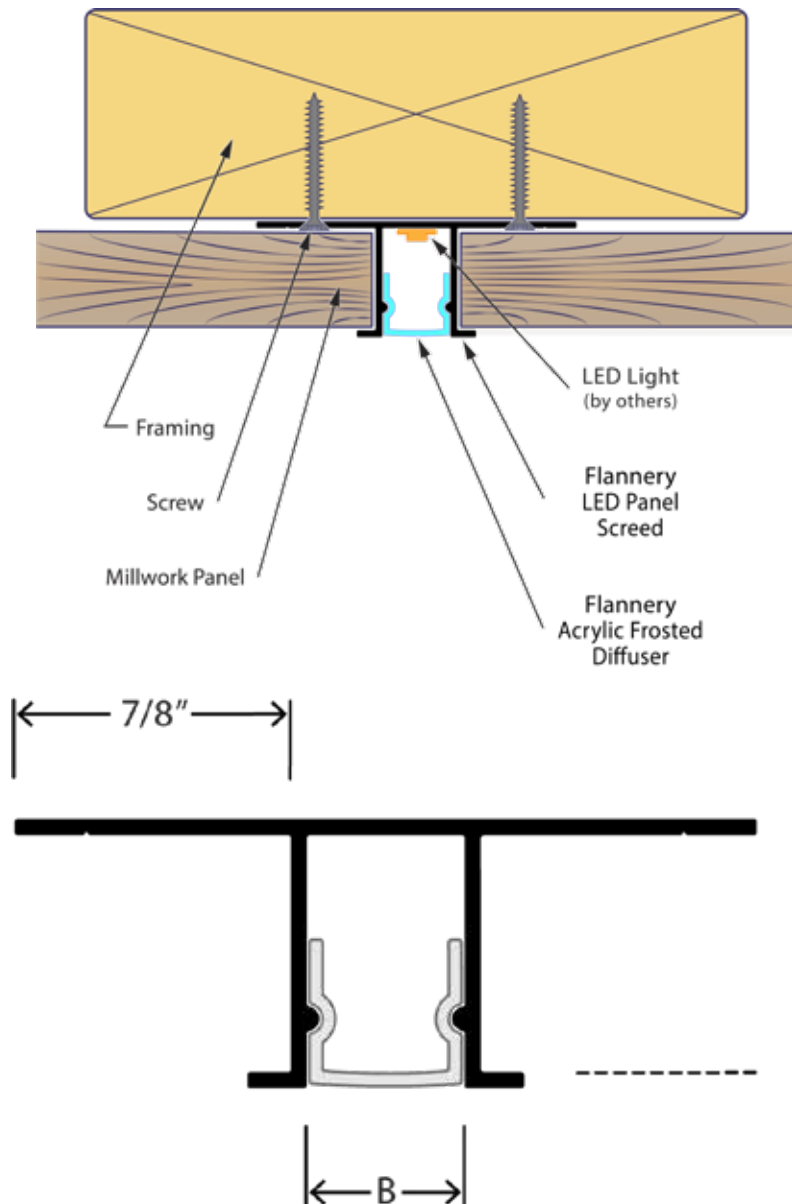

## TRIM PURPOSE

Flannery's LED Panel Screeds (LPS) create a linear light reveal between millwork panels on vertical walls or ceilings. The LED Panel Screeds have a 3/16" key to hide the unfinished edges of the millwork paneling. Flannery's LED Panel Screed comes with a frosted diffuser and allows for a 1/2" wide or smaller LED strip to be applied to the aluminum reveal (LED's and wiring are not provided).

## SPECIFICATIONS

Flannery's LED Trims are standard extruded aluminum alloy 6063 T5 and have a .050" nominal wall thickness. LED Reveals come in 10' lengths and shall have a standard Mill Finish (for field priming & painting) or a Clear Anodized Finish. Other factory finishes and custom paint orders, including Chem-film or Primer, are available.

## PRODUCT CHART

PART NO.	"A" DEPTH	"B" WIDTH	PANEL SIZE
LPS 50-50	1/2"	1/2"	1/2"
LPS 75-50	3/4"	1/2"	3/4"

# LED FLUSH SCREED

## TRIM PURPOSE

Flannery's LED Flush Screeds (LFS) create a linear light reveal between millwork panels on vertical walls or ceilings. The LED Flush Screed allows for a clean transition for an LED light strip between two finished edge millwork panels. Flannery's LED Flush Screed comes with a frosted diffuser and allows for a 1/2" wide or smaller LED strip to be applied to the aluminum reveal (LED's and wiring are not provided).

## SPECIFICATIONS

Flannery's LED Trims are standard extruded aluminum alloy 6063 T5 and have a .050" nominal wall thickness. LED Reveals come in 10' lengths and shall have a standard Mill Finish (for field priming & painting) or a Clear Anodized Finish. Other factory finishes and custom paint orders, including Chem-film or Primer, are available.

## PRODUCT CHART

PART NO.	"A" DEPTH	"B" WIDTH	PANEL SIZE
LFS 50-50	1/2"	1/2"	1/2"
LFS 75-50	3/4"	1/2"	3/4"

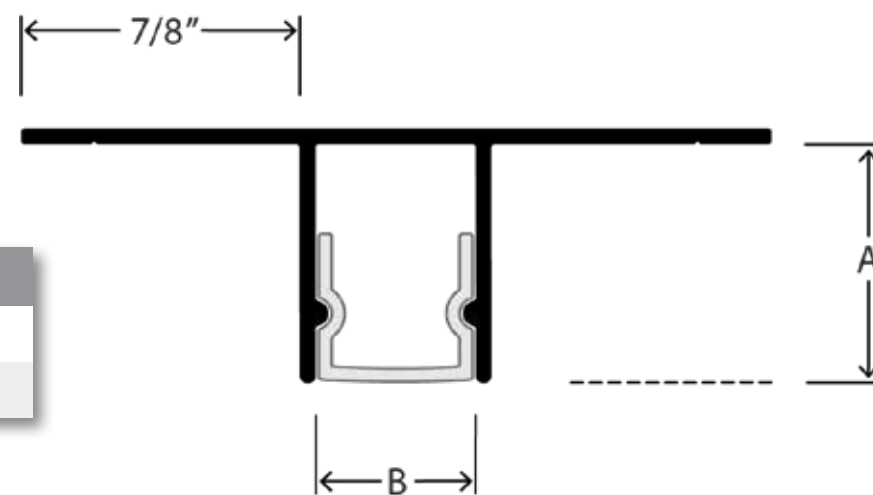
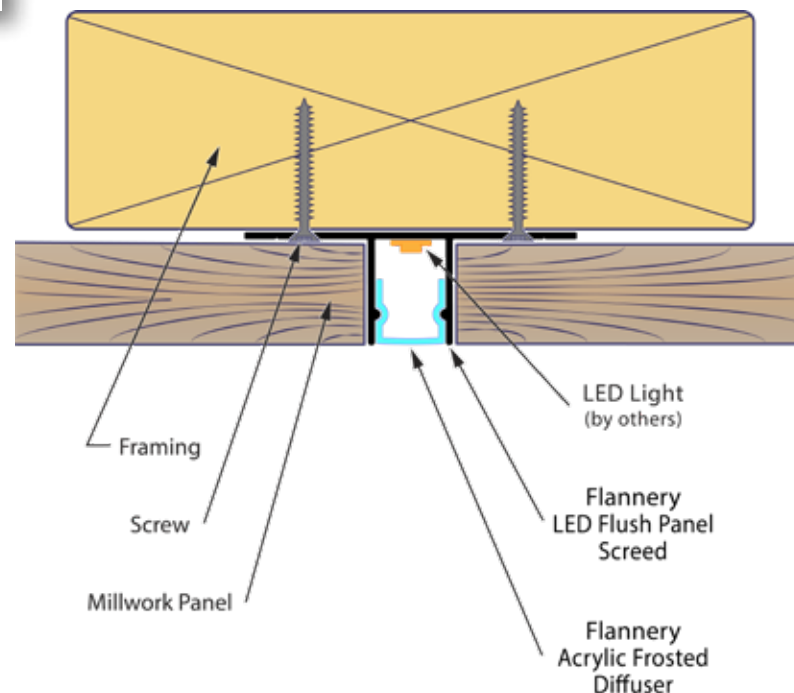







# **INTERSECTIONS & RADIUS**

## FACTORY INTERSECTIONS FOR INTERIOR TRIMS

The use of Aluminum Drywall Trims in any project is going to bring a certain design standard that will go beyond the normal flat gypsum board surface. These trims are meant to enhance and expand the banal wall design which means that they will often cross paths with each other along the drywall plane. Intersecting lines of trim on a wall will break up the "flat-panel" effect of a typical wall and convert it into a piece of artwork. In order to achieve this level of concept, factory cut and welded intersections is paramount.

Flannery's factory fabricated intersections and corners for interior trims are manufactured in house and can be made with the same or different moldings. The trims are mitered and then heli-arc welded at the installation flanges, so that every weld will be hidden once the compound joint and finish for the drywall is completed. The standard factory intersection or corner comes with 6" legs from the center point of the reveal, but custom leg lengths can be ordered.

When considering the cost of field cutting intersections and corners from Flannery's Aluminum Drywall Trims versus ordering factory fabricated intersections, consider the following:

1. Flannery can mass produce any type of standard intersection within days.
2. All intersections will be cut to the exact degree of miter required for the job.
3. Labor costs in the field are reduced due to the ease of installing the fabricated intersection quickly and then running the required straight piece of trim to that intersection with no extra field cutting.
4. Fabricated intersections and corners will be welded together so that they never separate due to metal expansion and contraction after installation.

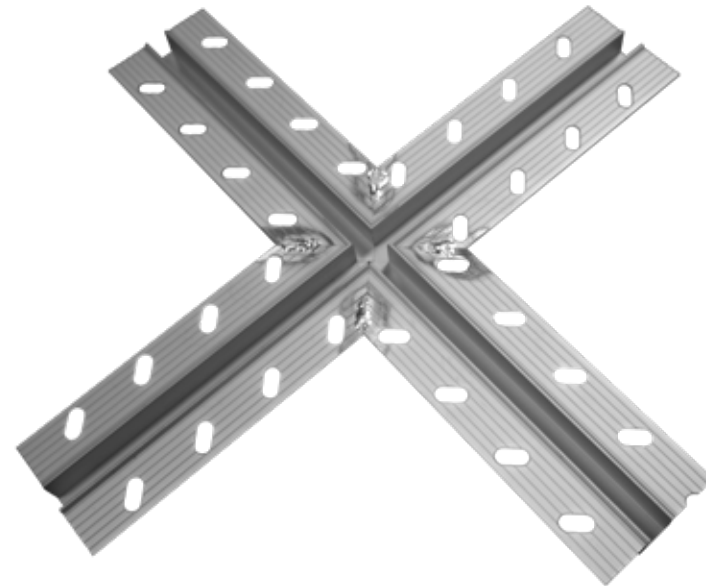
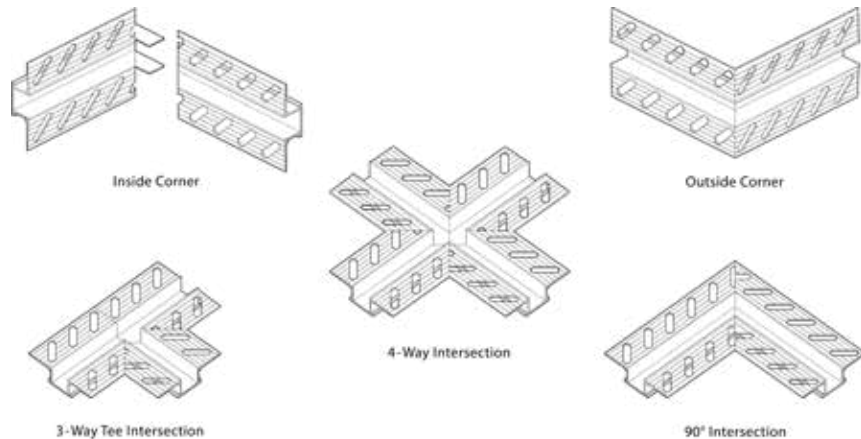





## TRIM BENDING AND RADIUS

Many of Flannery's Aluminum Drywall trims can be bent and radiused to follow the contours and turns of a curved wall or archway. This allows for the designer to have the freedom to run our trim along a convex surface to maintain their design concept parallel to a standard vertical wall or ceiling.

Flannery does all of its own bending in house to ensure the proper radius dimension is maintained and to reduce overall lead times for such a custom fabrication. Radiused material is bent to a project's dimensional requirements and is considered a custom product. Aluminum Drywall Trims can be bent in several different directions depending on the purpose of the trim and the direction that the curve of the drywall plane takes.

Here are some things you should consider when ordering radiused material:

1. All Trim Radius is a factory curved or bent piece of material that is necessary when trim runs along a "curved" or "radiused" plane.
2. Radius Shapes are formed from 10' pieces of material. Typically, only 9' of that piece of material will be usable for installation due to machining marks.
3. Radius Order Forms can be downloaded at [www.flannerytrim.com](http://www.flannerytrim.com) under the specific product page of the trim being bent.
4. A Flannery Radius technician can review architectural drawings to assist in the ordering of custom radius work.
5. Flannery accepts templates if a radius is complex or undefined by the architectural plans.
6. Flannery can also provide shop drawings for any project.

When placing an order for radius with Flannery, the following information will be required to complete the project:

1. Product Type (i.e. product code) and Finish Required
2. Direction of Bend (Inside Curve, Outside Curve, Arch or Reverse Arch)
3. Dimension or Size of Radius (in inches or feet)
4. Point of Measurement (the point on the trim where the radius dimension is measured to)
5. Quantity of Pieces Required

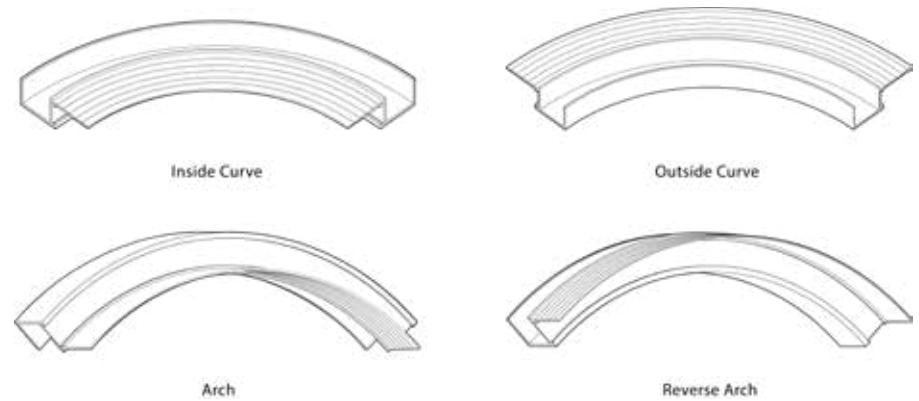

## ALUMINUM ALIGNMENT SPLICES

Many of Flannery's Drywall Trims are available with Aluminum Alignment Splices. Straight Splices are free of charge and come in the box with our trims. Straight Splices assist the installer in aligning and joining aluminum drywall trims together along a straight plane. Installers who cut their own miters in the field can use our Special Corner Splices and 90° Intersection Splices to bring the cut pieces together for a tight and clean miter joint.

## REVEAL END CAPS

Flannery offers two types of End Caps for certain Aluminum Drywall Trims. The two types of Reveal End Caps are "Standard End Caps" and "Tapeable Reveal End Caps". End Caps create a termination point for any Drywall Reveal where the reveal may end in the middle of a wall or against a dissimilar material such as a door or window frame.

**Standard End Caps:** Flannery's Standard End Caps are a U or L-Shaped piece of aluminum that slide onto the end of various Aluminum Drywall Trims that have their run terminated into a dissimilar material such as a door or window frame.

**Tapeable End Caps:** Flannery's Tapeable End Caps come with a taping flange and hook to the end of a reveal with two special aluminum splices to ensure a clean termination point (no glue required). The Tapeable End Cap is perfect for when a Drywall Reveal terminates in the middle of a horizontal wall or gypsum board ceiling and the end of the reveal needs to be finished to the drywall.

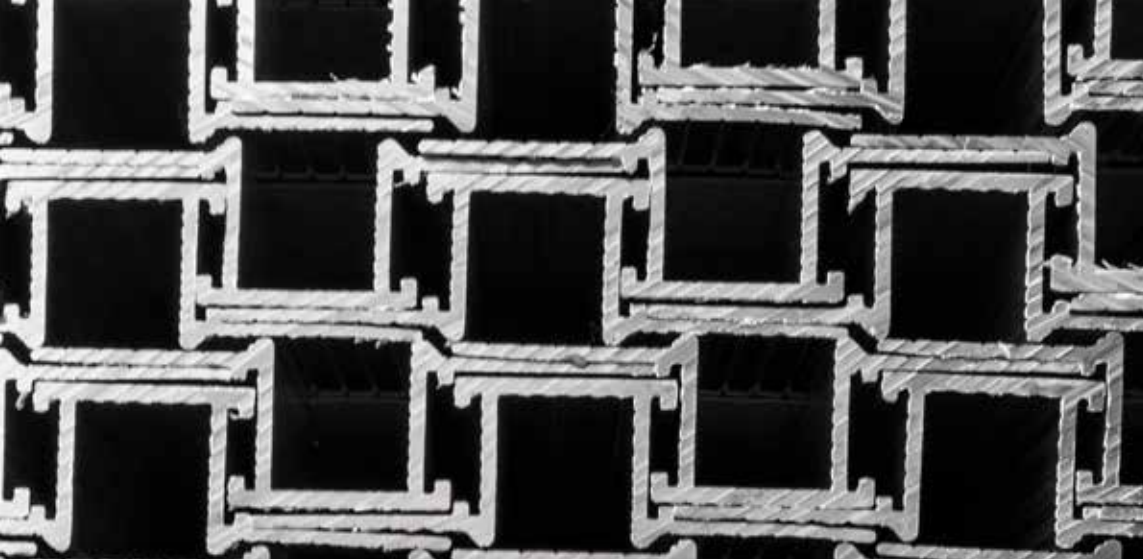

# PRODUCT SPECIFICATIONS

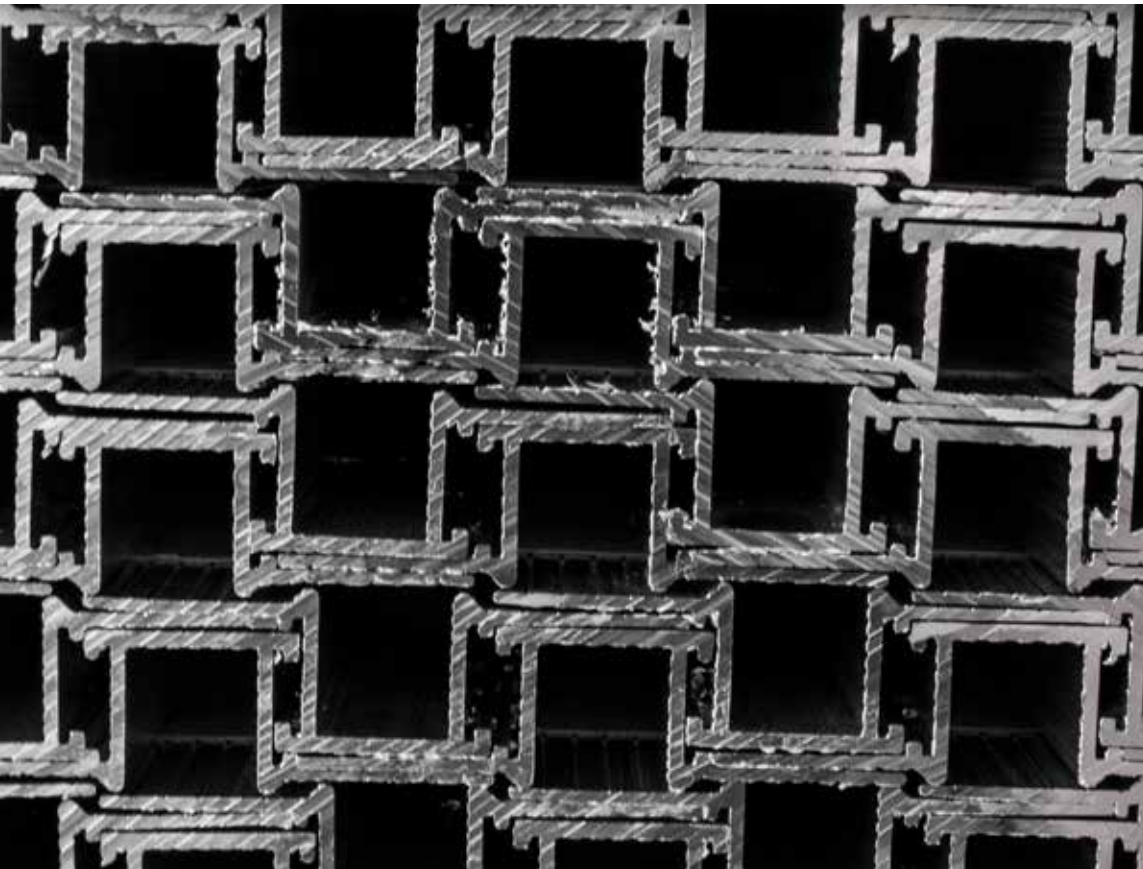



## PRODUCT SPECIFICATIONS

---

Flannery recommends that any installer of Aluminum Drywall Trims properly layout and coordinate the install of trims along with the drywall or gypsum board panels that will be utilized in a given installation. Most Aluminum Drywall Trims are installed after the drywall has been hung, which makes installation planning so paramount in reducing labor costs and ensuring the desired design aesthetic.

### INSTALLATION INSTRUCTIONS FOR INTERIOR MOLDING

1. Moldings with tapeable flanges are to be installed after the drywall/gypsum board has been installed. The installer must provide space for the moldings at the time of drywall/gypsum board installation or cut the drywall/gypsum board with a router. (Moldings without tapeable flanges are to be installed prior to the drywall/gypsum board being installed.)
2. The framing should provide a backer so that moldings can be attached with #6 drywall screws 16" on center.
3. Before the taping process begins, installation flanges should be cleaned. If veneer plaster is specified, the installation flanges must be treated with a bonding agent. Reveals should be masked to prevent compound joint, drywall mud or texture overspray from entering the reveal opening.
4. Painted aluminum moldings should be masked with vinyl tape. Use cloth or vinyl tape specifically manufactured for masking anodized aluminum trims.
5. Drywall tape should not overlap the edge of the reveal. An 8" wide trowel should be used to apply the final skim coat.
6. Fiberglass or self-adhesive drywall tape will shorten taping time and assist in the prevention of possible cracking.

### ALUMINUM DRYWALL TRIM ALLOY & COMPOSITION

Flannery's Aluminum Drywall Trims are standard extruded aluminum alloy 6063 T5 and have a typical .050" nominal wall thickness. Aluminum Drywall Trims are aesthetic trims which are not intended to hold or support the weight of any gypsum panel system.

Aluminum Drywall Trims come in 10' lengths and shall have a standard Mill Finish (for field priming & painting) or Clear Anodized Finish. Custom anodizing, Chem-Film finish, factory priming and/or painting and polishing is also available.

### HANDLING ALUMINUM TRIMS

Personal protection equipment should be utilized when handling and installing aluminum trims. Gloves and eye protection must be worn when handling aluminum trims as well as ear protection when cutting them.

### CUTTING ALUMINUM MOLDINGS

Flannery recommends that full ten-foot lengths be used wherever possible. Aluminum Moldings can be cut with a chop saw, using a 125-150-tooth carbide-tip blade for non-ferrous metal. An abrasive cut-off wheel should not be used to cut aluminum trims. Blade lubricant (WD-40 or grease stick) must be applied to the blade before each cut. Lubricant should be cleaned off of trim prior to installation.

### STEPS FOR FIELD PAINTING

Mill Finish (raw) or Chem-Film Treated Aluminum Moldings

1. Clean and treat moldings in accordance with the paint manufacturer's specifications.
2. Use a primer recommended by the paint manufacturer.
3. Apply the paint coat according to the paint manufacturer's specifications.

Clear Anodized Aluminum Moldings

If field painting of clear anodized moldings is necessary, the following steps must be taken to improve the bond between the paint and the aluminum surface:

1. Clean and treat moldings with an acid etch solution (i.e. mild concentration of muriatic acid), then rinse thoroughly and allow to dry. An "acid-etched" primer is also available depending on the paint manufacturer's recommendations.
2. Use a primer recommended by the paint manufacturer.
3. Apply the paint coat according to the paint manufacturer's specifications.
4. Flannery makes no guarantees, nor accepts any responsibility, for the performance of field-applied coatings over anodized finishes.

## FACTORY FINISHES

---

### MILL FINISH

"Mill Finish" is the term that Flannery uses to describe its aluminum trims that have no finish applied to them. In other words, it is raw aluminum from our mill and it can be field primed and painted. Typically, Mill Finish has a shiny or "mirror-like" appearance with some visible manufacturing lines.

Mill Finish trims must be cleaned before field priming occurs. Typically, soapy water should clean most oils or production residue from the surface of the trim. Sufficient drying time should be planned for before primer is applied. The paint manufacturer should be consulted when choosing a primer for aluminum trims. Mill Finish trims should never be left exposed for an extended period of time, since this may allow the metal to begin the oxidation process. All aluminum trims must be covered with a proper paint or anodized finish.

### CLEAR ANODIZED FINISH

The standard stock finish for Flannery's trims (besides Mill Finish) is a Clear Anodized Finish (Architectural 200R1). The Clear Anodized finish is an electrochemical conversion process that deposits an oxide film on the aluminum trim. A natural oxidation process occurs on bare aluminum, however producing the oxidation process artificially creates a thicker, harder, and more durable "oxide film." The Clear Anodized finish is an extremely durable finish and is resistant to most forms of corrosion.

Standard Clear Anodized Finish- Architectural 200R1 medium etch (AA-M32C10A21). Thickness of anodic coating shall be tested in accordance with ASTM B-244-68.

### COLOR ANODIZING

Special Color Anodized finishes are also available if required. Gold Anodized, Champagne Anodized, Black Anodized, and Bronze Anodized finishes can be ordered. Bronze Anodized can be ordered in three different color shades: Light, Medium, and Dark Bronze. Please note: Color Anodized Finishes can vary from one piece of trim to another. This is one of the characteristics to the anodizing process and must be considered before any orders are placed. Typically, the color of the anodizing will fall within a certain range, which usually can be determined prior to anodizing. Check with Flannery for details.

Color Anodized Finish- Two-step impregnated color Class II Architectural .40-.70 mils (AA-M12C22A33). Thickness of coating shall be tested in accordance with ASTM B244-68.

### POLISHED ANODIZING

Flannery offers special "Brushed" or "Polished" anodized finishes that imitate finishes found on other types of metals including Stainless Steel, Brushed Stainless Steel, Brass and other metals. These types of anodized finishes require a sample of the desired finish to be submitted to Flannery for quotation and minimum order quantities may apply. Some smaller reveals may not be available with these special finishes due to production restrictions.

### CHEMICAL CONVERSION COAT FINISH

Chem-film (aka Alodine) is a chemical conversion process that prepares aluminum extrusions for field painting. It is a multi-step cleaning and aluminum preparation process. First, it cleans the aluminum trim and then it acts as a protective coating until primer and paint can be applied. If your job requires field painting, a chemical conversion coating can be specified.

Chem-film/Alodine- Treatment of aluminum moldings to conform to ASTM D 1730 Type B and MIL-C-5541A.

## **KYNAR® PAINT FINISH**

Kynar® is a 70% fluoropolymer resin based 2-coat baked on paint that is offered by Flannery as an optional finish where high durability is needed or an existing color must be matched. Kynar® finishes are highly resistant to chalking and ultraviolet deterioration. They are also highly resistant to chemicals, salt spray, and industrial pollutants. Flannery recommends these finishes for trims on exteriors in harsh environments including coastal areas where salt air is most common. Kynar® paint finishes are available in custom colors. Please note that some finishes will require a Kynar® XL (with topcoat) finish due to the exotic nature of the color. Please have the color code or sample available when requesting a quote for these custom colors.

Kynar® Paint Finishes shall meet or exceed AAMA 605.2 Specification "Voluntary Specification for High Performance Organic Coatings on Architectural Extrusion Panels." Kynar® meets or exceeds a nominal dry film thickness of 1.2 mil. (Kynar® is a registered trademark of Atochem North America, Inc).

## **POWDER-COATED PAINT FINISHES**

Flannery offers Powder-Coated Paint Finishes on all of its aluminum trims. Flannery's factory powder-coated paint process can match any paint manufacturer's paint number or match a custom paint color to provide the desired aesthetic finish. Powder-coated paint finishes are applied to the aluminum trims after a chem-film finish and factory primer has been applied. Please have the color code or sample available when requesting a quote for these custom colors.

Powder-Coated Paint finishes shall meet or exceed the dry film thickness of 1.2 mil as specified in AAMA 2605 SEC 4.3. Color uniformity will meet or exceed the requirements of AAMA 2605 SEC 7.1.

This brochure presents general guidelines and suggestions for the installation of Flannery trims and products. The purpose of these general guidelines and suggestions is to aid in a successful interior or exterior finish based on the Uniform Building Code and industry standards. No one catalog or brochure can address all of the unique specifics or installation details that occur from one project to another. Flannery recommends that every installer be familiar, or become acquainted with, common interior or exterior trim installation practices before installing any of Flannery's many trims and products. Flannery also recommends that the specifying architect, engineer, and general contractor be consulted with as well.









**Flannery, Inc**

Specialty Aluminum Trims

7400 Oak Grove Road

Fort Worth, TX 76140

[flannerytrim.com](http://flannerytrim.com) - 800.765.7585





**Flannery, Inc**  
Specialty Aluminum Trims



**ALUMINUM DRYWALL TRIMS**

